

# Close Hinge Catalog



缓冲玻璃合页 180° (单开)  
Soft Close Hinge Series (Single Side Opening)



玻璃合页 180 度 (单开) Glass Hinge 180° (Single Side Opening)	
应用 (Application)	玻璃对玻璃 180 度 (Glass To Glass 180°)
材质 (Material Quality)	精铸不锈钢 (Precision Cast Stainless Steel)
开门方向 (Opening Trend)	单向开门 (Unidirectional Swinging Door)
最大门重量 (Maximum Door Weight)	45 公斤 (克) (45 Kg (Double))
适合门宽度 (Suitable Door Width)	700 毫米 (700mm)
最大开启角度 (Maximum Opening Angle)	180 度 (°)
适用于钢化玻璃 (Suitable For Tempered Glass)	8-12 毫米 (8-12 mm)

型号 (Model)		1 个承重 (Bearing Weight/2 Units)		2 个承重 (Bearing Weight/2 Units)	
		8/10/12mm 玻璃 (Glass)		8/10/12mm 玻璃 (Glass)	
重量 (公斤) Weight (Kg)	宽度 (毫米) Width (mm)	重量 (公斤) Weight (Kg)	宽度 (毫米) Width (mm)	重量 (公斤) Weight (Kg)	宽度 (毫米) Width (mm)
45	700	60	800		



产品详细信息 Product Details



可选标准饰面 (Optional Standard Finishes)		颜色 (Color)	
型号 - Model No.	表面处理 - Finish	精铸 PPS	黑色 PPS
PS5	抛光 Mirror	精铸 MBL	哑光黑 Matt Black
MBL	哑光 Matt Black	精铸 SSS	拉丝 Satin
SS5	拉丝 Satin	精铸 TG	钛金 Titanium Gold
TG	钛金 Titanium Gold	精铸 RG	玫瑰金 Rose Gold
RG	玫瑰金 Rose Gold	精铸 GM	枪灰 Gun Metal
GM	枪灰 Gun Metal		

配置: 垫片 (Gasket)

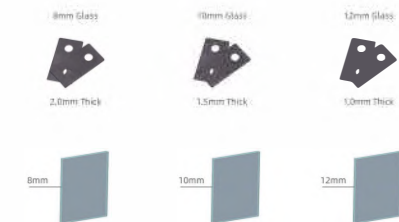

外观尺寸 Appearance Size

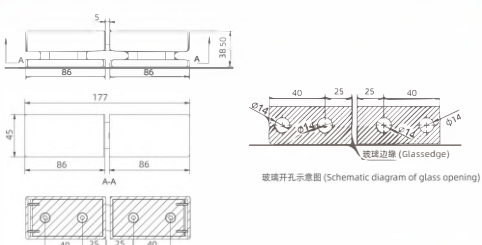

产品特点 Product Features

- 由精铸不锈钢制成。
- 单向开启, 90°定位。
- 适用于 8/10/12mm 玻璃
- 小于 85°时门自动关闭, 到 25°时起缓冲效果。
- 可选功能

Made Of Precision Cast Stainless Steel.  
Single Side Opening, 90° Positioning  
● Suitable For 8/10/12mm Glass  
● Automatic closing from 85° and 85°  
50 ft closing from +25° and -25°  
● Optional Functions



极窄门框缓冲玻璃转轴  
Extremely Narrow Door Frame Soft Close Glass Pivot



极窄门框缓冲玻璃转轴 Extremely Narrow Door Frame Soft Close Glass Pivot	
应用 (Application)	极窄门框门配件 (Pivot Door Accessories)
材质 (Material Quality)	精铸不锈钢 (Precision Cast Stainless Steel)
开门趋势 (Opening Trend)	内开外开门 (Swing Doors)
最大门重量 (Maximum Door Weight)	35 公斤 (35kg)
适合门宽度 (Suitable Door Width)	700 毫米 (700mm)
最大开启角度 (Maximum Opening Angle)	90 度 (°)
适用于钢化玻璃 (Suitable For Tempered Glass)	8-12 毫米 (8-12 mm)

型号 (Model)		1 个承重 (Bearing Weight/1 Unit)		2 个承重 (Bearing Weight/2 Units)	
		8/10/12mm 玻璃 (Glass)		8/10/12mm 玻璃 (Glass)	
重量 (公斤) Weight (Kg)	高度 (毫米) Width (mm)	重量 (公斤) Weight (Kg)	高度 (毫米) Width (mm)	重量 (公斤) Weight (Kg)	高度 (毫米) Width (mm)
35	700	35	800		

外观尺寸 Appearance Size

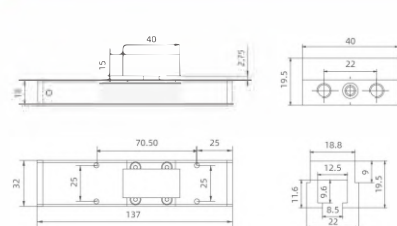

产品特点 Product Features

- 由精铸不锈钢制成。
- 单向开启, 90°定位。
- 适用于 8/10/12mm 玻璃
- 小于 85°时门自动关闭, 到 25°时起缓冲效果。
- 可选功能

Made Of Precision Cast Stainless Steel.  
Single Side Opening, 90° Positioning  
● Suitable For 8/10/12mm Glass  
● Automatic closing from 85° and 85°  
Soft closing from +25° and -25°  
● Optional Functions



产品详细信息 Product Details



可选标准饰面 (Optional Standard Finishes)		颜色 (Color)	
型号 - Model No.	表面处理 - Finish	精铸 PPS	黑色 PPS
PS5	抛光 Mirror	精铸 MBL	哑光黑 Matt Black
MBL	哑光 Matt Black	精铸 SSS	拉丝 Satin
SS5	拉丝 Satin	精铸 TG	钛金 Titanium Gold
TG	钛金 Titanium Gold	精铸 RG	玫瑰金 Rose Gold
RG	玫瑰金 Rose Gold	精铸 GM	枪灰 Gun Metal
GM	枪灰 Gun Metal		

配置: 型材 (Profile)

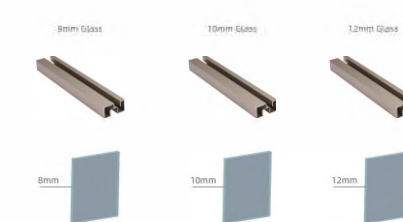

缓冲玻璃夹转轴 (开孔)  
Soft close glass clamp shaft(opening)



缓冲玻璃夹转轴 (开孔) Buffer Glass Clamp Shaft (Perforated)	
应用 (Application)	无框玻璃门 (Frameless glass door)
材质 (Material Quality)	精铸不锈钢 (Precision Cast Stainless Steel)
开门动向 (Opening Trend)	内外开门 (Swing Doors)
最大门重量 (Maximum Door Weight)	35 公斤 (双) (35 kg (Double))
适合门宽度 (Suitable Door Width)	700 毫米 (700mm)
最大开启角度 (Maximum Opening Angle)	90 度 (90°)
适用于钢化玻璃 (Suitable For Tempered Glass)	8-12 毫米 (8-12 mm)

型号 (Model)	2 个承重 (Bearing Weight/2 Units)		3 个承重 (Bearing Weight/3 Units)	
	8/10/12mm 玻璃 (Glass)	重量 (公斤) Weight (kg)	8/10/12mm 玻璃 (Glass)	重量 (公斤) Weight (kg)
	宽度 (毫米) Width (mm)	50	宽度 (毫米) Width (mm)	800



外观尺寸 Appearance Size

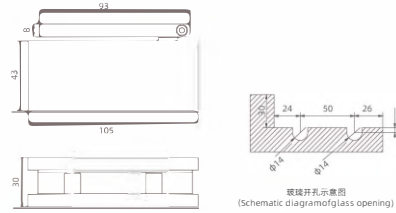

产品详细信息 Product Details



可选标准饰面 (Optional Standard Finishes)	
型号 - Model No.	表面处理 - Finish
PSS	镜光 Mirror
MBL	哑黑 Matt Black
SSS	拉丝 Satin
TG	钛金 Titanium Gold
RG	玫瑰金 Rose Gold
GM	枪灰 Gun Metal

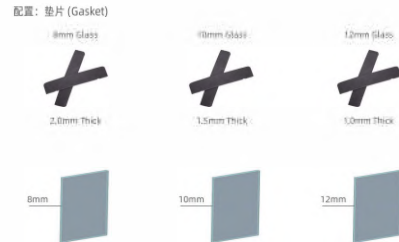

产品特点 Product features

- 由精铸不锈钢制成。
- 双重运动、内外开启, 90°定位。
- 适用于 8/10/12mm 玻璃
- 小于 85°时门自动关闭, 到 25°时起缓冲效果。
- 可选功能

Made Of Precision Cast Stainless Steel.  
Dual Movement, Internal And External Opening, 90° Positioning  
● Suitable For 8/10/12mm Glass  
● Automatic closing from 85° and 85°  
Soft closing from +25° and -25°  
● Optional Functions



缓冲玻璃夹转轴 (无孔)  
Soft Close Glass Clamp Shaft (Free Hole)



缓冲玻璃夹转轴 (无孔) Buffer Glass Clamp Shaft (Free Hole)	
应用 (Application)	无框玻璃门 (Frameless Glass Door)
材质 (Material Quality)	精铸不锈钢 (Precision Cast Stainless Steel)
开门动向 (Opening Trend)	内外开门 (Swing Doors)
最大门重量 (Maximum Door Weight)	35 公斤 (双) (35 kg (Double))
适合门宽度 (Suitable Door Width)	700 毫米 (700mm)
最大开启角度 (Maximum Opening Angle)	90 度 (90°)
适用于钢化玻璃 (Suitable For Tempered Glass)	8-12 毫米 (8-12 mm)

型号 (Model)	2 个承重 (Bearing weight/2 units)		3 个承重 (Bearing weight/3 units)	
	8/10/12mm 玻璃 (Glass)	重量 (公斤) Weight (kg)	8/10/12mm 玻璃 (Glass)	重量 (公斤) Weight (kg)
	宽度 (毫米) Width (mm)	50	宽度 (毫米) Width (mm)	800



外观尺寸 Appearance Size

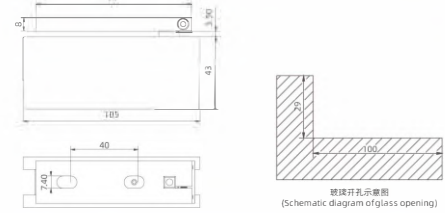

产品详细信息 Product Details



可选标准饰面 (Optional Standard Finishes)	
型号 - Model No.	表面处理 - Finish
PSS	镜光 Mirror
MBL	哑黑 Matt Black
SSS	拉丝 Satin
TG	钛金 Titanium Gold
RG	玫瑰金 Rose Gold
GM	枪灰 Gun Metal

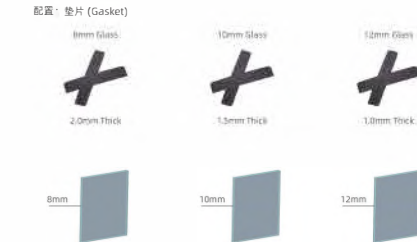

产品特点 Product features

- 由精铸不锈钢制成。
- 双重运动、内外开启, 90°定位。
- 适用于 8/10/12mm 玻璃
- 小于 85°时门自动关闭, 到 25°时起缓冲效果。
- 可选功能

Made Of Precision Cast Stainless Steel.  
Dual Movement, Internal And External Opening, 90° Positioning  
● Suitable For 8/10/12mm Glass  
● Automatic closing from 85° and 85°  
Soft closing from +25° and -25°  
● Optional Functions

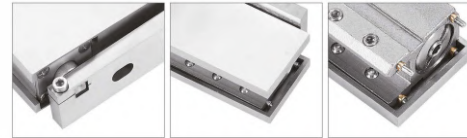

缓冲升降玻璃合页  
Soft Close Lifting Glass Hinge



缓冲升降玻璃合页 Soft Close Lifting Glass Hinge	
应用 (Application)	玻璃对玻璃 180度 (Glass To Glass 180°)
材质 (Material Quality)	精铸不锈钢 (Precision Cast Stainless Steel)
开门方向 (Opening Trend)	单向升降开门 (Single Side Lifting Door Opening)
最大门重量 (Maximum Door Weight)	45 公斤 (45kg)
适合门宽度 (Suitable Door Width)	700 毫米 (700mm)
最大开启角度 (Maximum Opening Angle)	180度 (180°)
适用于钢化玻璃 (Suitable For Tempered Glass)	8-12 毫米 (8-12 mm)

型号 (Model No.)		门重量 (Bearing Weight/3 Units)	
B/10/12mm 玻璃 (Glass)		8/10/12mm 玻璃 (Glass)	
重量 (公斤) Weight (kg)	宽度 (毫米) Width (mm)	重量 (公斤) Weight (kg)	宽度 (毫米) Width (mm)
45	700	60	800



产品详细信息 Product Details



可选标准饰面 (Optional Standard Finishes)	
型号: Model No.	表面处理: Finish
PSS	镜光 Mirror
MBL	哑黑 Matt Black
SSS	拉丝 Satin
TG	钛金 Titanium Gold
RG	玫瑰金 Rose Gold
GM	枪灰 Gun Metal

配置: 垫片 (Gasket)

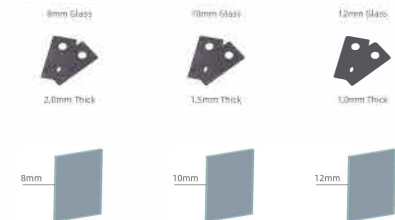

外观尺寸 Appearance Size

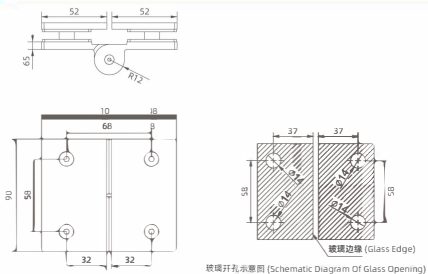

产品特点 Product features

- 由精铸不锈钢制成。
- 单向升降开启, 90°定位。
- 适用于 8/10/12mm 玻璃
- 小于 85°时门自动关闭, 到 25°时起缓冲效果。
- 可选功能
- Made Of Precision Cast Stainless Steel.
- Unidirectional Lifting Opening, 90° Positioning.
- Suitable For 8/10/12mm Glass
- Automatic closing from 85° and 85°
- Soft closing from +25° and -25°
- Optional Functions



缓冲门夹  
Soft Close Patch Fittings



缓冲门夹 Soft Close Patch Fittings	
应用 (Application)	各种钢化玻璃门 (Various Tempered Glass Doors)
材质 (Material Quality)	铝合金、不锈钢 (Aluminum Alloy, Stainless Steel)
开门方向 (Opening Trend)	双向开门 (Swing Doors)
最大门重量 (Maximum Door Weight)	E9000A (45-60) (45-60kg) E9000B (60-80公斤) (60-80kg)
适合门宽度 (Suitable Door Width)	E9000A (600-700毫米) (600-700mm) E9000B (700-1000毫米) (700-1000 mm)
最大开启角度 (Maximum Opening Angle)	90度 (90°)
适用于钢化玻璃 (Suitable For Tempered Glass)	10-12 毫米 (10-12 mm)

型号 (Model No.)		轻型系列 (Standard)		重型系列 (Heavy duty series)	
		10/12mm 玻璃 (Glass)		8/10/12mm 玻璃 (Glass)	
重量 (公斤) Weight (kg)	高度 (毫米) Width (mm)	重量 (公斤) Weight (kg)	高度 (毫米) Width (mm)	重量 (公斤) Weight (kg)	高度 (毫米) Width (mm)
60-80	90mm	100-120	110mm		

外观尺寸 Appearance Size

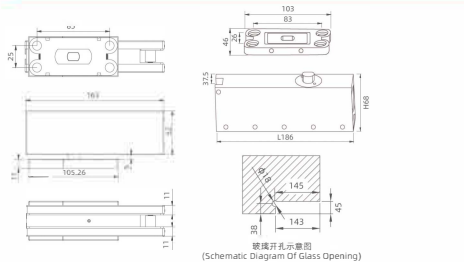

产品特点 Product features

- 由精铸不锈钢制成。
- 单向升降开启, 90°定位。
- 适用于 10/12mm 玻璃
- 小于 85°时门自动关闭, 到 25°时起缓冲效果。
- 可选功能
- Made Of Precision Cast Stainless Steel.
- Unidirectional Lifting Opening, 90° Positioning.
- Suitable For 10/12mm Glass
- Automatic closing from 85° and 85°
- Soft closing from +25° and -25°
- Optional Functions



产品详细信息 Product Details



可选标准饰面 (Optional Standard Finishes)	
型号: Model No.	表面处理: Finish
PSS	镜光 Mirror
MBL	哑黑 Matt Black
SSS	拉丝 Satin
TG	钛金 Titanium Gold
RG	玫瑰金 Rose Gold
GM	枪灰 Gun Metal

配置: 垫片 (Gasket)



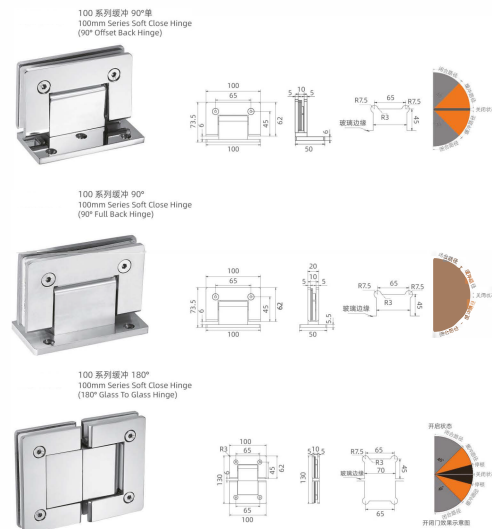
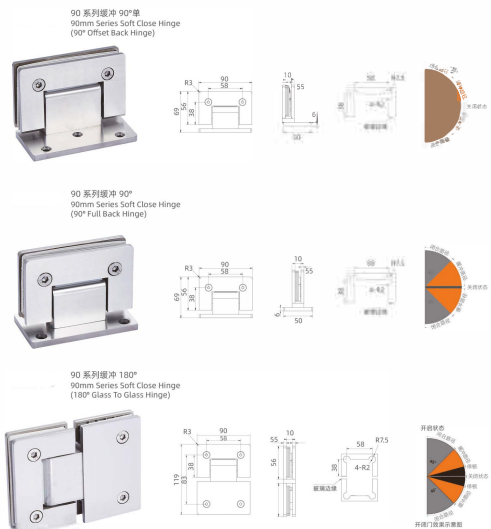

系列缓冲铰链 Soft Close Hinge	
应用 (Application)	墙对玻璃 / 玻璃对玻璃 (Wall To Glass/Glass To Glass)
材质 (Material Quality)	精铸不锈钢 (Precision Cast Stainless Steel)
开门动向 (Opening Trend)	双向开门 (Swing Door)
最大门重量 (Maximum Door Weight)	45 公斤 (45kg)
适合门宽度 (Suitable Door Width)	700 毫米 (700mm)
最大开启角度 (Maximum Opening Angle)	90 度 (90°)
适用于钢化玻璃 (Suitable For Tempered Glass)	8-12 毫米 (8-12mm)

型号 (Model)	2个承重 (Bearing Weight/2 Units)		3个承重 (Bearing Weight/3 Units)	
	8/10/12mm 玻璃 (Glass)	重量 (公斤) (Weight (kg))	8/10/12mm 玻璃 (Glass)	重量 (公斤) (Weight (kg))
	40	40	30	30

产品详细信息 Product Details

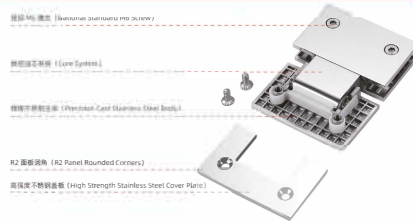

可选标准饰面 (Optional Standard Finishes)	
型号: Model No.	表面处理: Finish
PSS	抛光 Mirror
MBL	哑黑 Matt Black
SSS	拉丝 Satin
TG	钛金 Titanium Gold
RG	玫瑰金 Rose Gold
GM	枪灰 Gun Metal

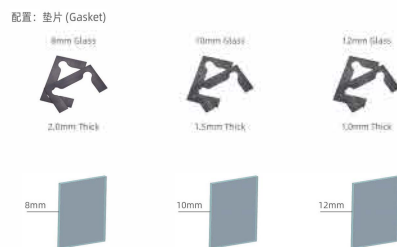

产品特点 Product Features

- 由精铸不锈钢制成。
- 双重运动, 内外开启, 90°定位。
- 适用于 8/10/12mm 玻璃
- 小于 85°时门自动关闭, 到 25°时起缓冲效果。
- 可选功能



系列缓冲铰链 Soft Close Hinge	
应用 (Application)	墙对玻璃 / 玻璃对玻璃 (Wall To Glass/Glass To Glass)
材质 (Material Quality)	精铸不锈钢 (Precision Cast Stainless Steel)
开门动向 (Opening Trend)	双向开门 (Swing Door)
最大门重量 (Maximum Door Weight)	45 公斤 (45kg)
适合门宽度 (Suitable Door Width)	700 毫米 (700mm)
最大开启角度 (Maximum Opening Angle)	90 度 (90°)
适用于钢化玻璃 (Suitable For Tempered Glass)	8-12 毫米 (8-12mm)

型号 (Model)	2个承重 (Bearing weight/2 unit)		3个承重 (Bearing weight/3 units)	
	8/10/12mm 玻璃 (Glass)	重量 (公斤) (Weight (kg))	8/10/12mm 玻璃 (Glass)	重量 (公斤) (Weight (kg))
	40	40	30	30

产品特点 Product Features

- 由精铸不锈钢制成。
- 双重运动, 内外开启, 90°定位。
- 适用于 8/10/12mm 玻璃
- 小于 85°时门自动关闭, 到 25°时起缓冲效果。
- 可选功能



产品详细信息 Product Details

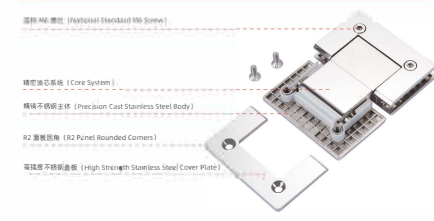

可选标准饰面 (Optional Standard Finishes)	
型号: Model No.	表面处理: Finish
PSS	抛光 Mirror
MBL	哑黑 Matt Black
SSS	拉丝 Satin
TG	钛金 Titanium Gold
RG	玫瑰金 Rose Gold
GM	枪灰 Gun Metal

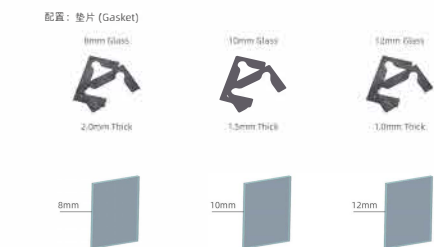

单向缓冲 90°防水铰链  
Soft Close Waterproof Hinge  
(Single Side Opening)

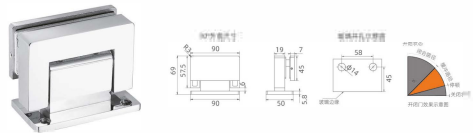

单向缓冲 180°防水铰链  
Soft Close Waterproof Hinge  
(Single Side Opening)

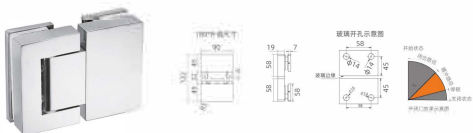

泳池 90°缓冲合页  
90° Soft Close Swimming Pool Hinge

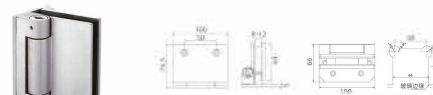

泳池 180°缓冲合页  
180° Soft Close Swimming Pool Hinge

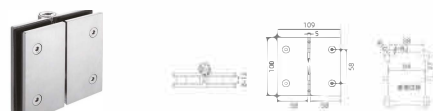

长方形液压 180°缓冲铰链  
180° Rectangular Hydraulic Hinge

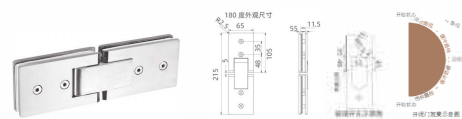

单向系列缓冲浴室夹 Soft Close Hinge (Single Side Opening)	
应用 (Application)	墙对玻璃 / 玻璃对玻璃 (Wall To Glass / Glass To Glass)
材质 (Material Quality)	精铸不锈钢 (Precision Cast Stainless Steel)
开门动角 (Opening Trend)	单向开门 (Single Side Opening)
最大门重量 (Maximum Door Weight)	45 公斤 (45kg)
适合门宽度 (Suitable Door Width)	700 毫米 (700mm)
最大开启角度 (Maximum Opening Angle)	90 度 (90°)
适用于钢化玻璃 (Suitable For Tempered Glass)	8-12 毫米 (8-12mm)

型号 (Model)	2 个承重 (Bearing Weight/2 Units)		3 个承重 (Bearing Weight/3 Units)	
	8/10/12mm 玻璃 (Glass)	重量 (公斤) (Weight (kg))	8/10/12mm 钢化 (Glass)	重量 (公斤) (Weight (kg))
40	100	100	100	100

产品特点 Product Features

- 由精铸不锈钢制成。
- 单向升降开启, 90°定位。
- 适用于 8/10/12mm 玻璃
- 小于 85°时门自动关闭, 到 25°时起缓冲效果。
- 可选功能

Made Of Precision Cast Stainless Steel.  
Unidirectional Lifting Opening, 90° Positioning.  
Suitable For 8/10/12mm Glass  
Automatic closing from +85° and -85°  
Soft closing from +25° and -25°  
Optional Functions



产品详细信息 Product Details

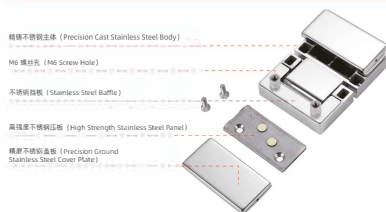

可选标准饰面 (Optional Standard Finishes)

型号: Model No.	表面处理: Finish	颜色: Color
PSS	抛光 Mirror	银色 Silver
MBL	哑黑 Matt Black	黑色 Black
SSS	拉丝 Satin	拉丝 Satin
TG	钛金 Titanium Gold	金色 Gold
RG	玫瑰金 Rose Gold	玫瑰金 Rose Gold
GM	枪灰 Gun Metal	枪灰色 Gun Metal

配置: 垫片 (Gasket)



缓冲玻璃合页 Soft Close Glass Hinge	
应用 (Application)	墙对玻璃 90 度 / 玻璃对玻璃 (Wall To Glass 90° / Glass To Glass)
材质 (Material Quality)	精铸不锈钢 (Precision Cast Stainless Steel)
开门动角 (Opening Trend)	单向开门 (Single Side Opening)
最大门重量 (Maximum Door Weight)	45 公斤 (45kg)
适合门宽度 (Suitable Door Width)	700 毫米 (700mm)
最大开启角度 (Maximum Opening Angle)	95 度 (95°)
适用于钢化玻璃 (Suitable For Tempered Glass)	8-12 毫米 (8-12mm)

型号 (model)	2 个承重 (Bearing Weight/2 Units)		3 个承重 (Bearing Weight/3 Units)	
	8/10/12mm 玻璃 (Glass)	重量 (公斤) (Weight (kg))	8/10/12mm 钢化 (Glass)	重量 (公斤) (Weight (kg))
40	100	100	100	100

产品特点 Product Features

- 由精铸不锈钢制成。
- 单向开启, 90°定位。
- 适用于 8/10/12mm 玻璃
- 小于 85°时门自动关闭, 到 25°时起缓冲效果。
- 可选功能

Made Of Precision Cast Stainless Steel.  
Single Side Opening, 90° Positioning.  
Suitable For 8/10/12mm Glass  
When The Angle Is Less Than 85°, The Door Will Automatically Close, And When It Reaches 25°, It Will Have A Soft Close Effect.  
Optional Functions

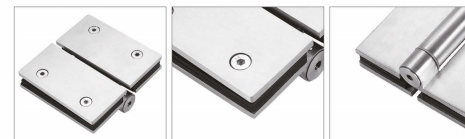

产品详细信息 Product Details



可选标准饰面 (Optional Standard Finishes)

型号: Model No.	表面处理: Finish	颜色: Color
PSS	抛光 Mirror	银色 Silver
MBL	哑黑 Matt Black	黑色 Black
SSS	拉丝 Satin	拉丝 Satin
TG	钛金 Titanium Gold	金色 Gold
RG	玫瑰金 Rose Gold	玫瑰金 Rose Gold
GM	枪灰 Gun Metal	枪灰色 Gun Metal

配置: 垫片 (Gasket)

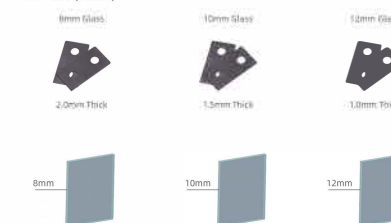

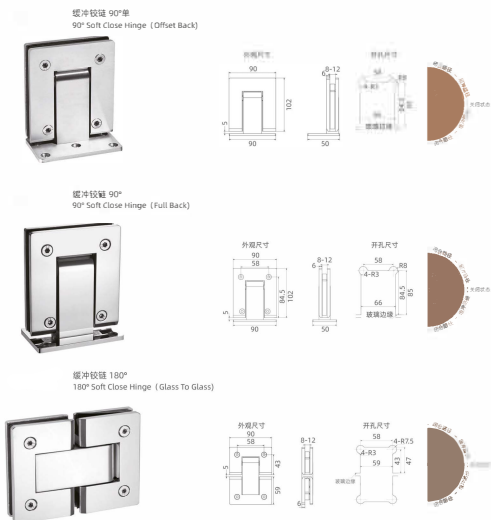

高芯缓冲铰链系列 Straight Core Buffer Hinge Series	
应用 (Application)	墙对玻璃 / 玻璃对玻璃 (Wall To Glass/Glass To Glass)
材质 (Material Quality)	精铸不锈钢 (Precision Cast Stainless Steel)
开门动角 (Opening Trend)	双向开门 (Swing Door)
最大门重量 (Maximum Door Weight)	45 公斤 (45kg)
适合门宽度 (Suitable Door Width)	700 毫米 (700mm)
最大开启角度 (Maximum Opening Angle)	90 度 (90°)
适用于钢化玻璃 (Suitable For Tempered Glass)	8-12 毫米 (8-12mm)

型号 (Model)	2 个承重 (Bearing Weight/2 Units)		3 个承重 (Bearing Weight/3 Units)	
	8/10/12mm 玻璃 (Glass)	重量 (公斤) (Weight (kg))	8/10/12mm 钢化 (Glass)	重量 (公斤) (Weight (kg))
48	100	100	100	100

产品特点 Product Features

- 由精铸不锈钢制成。
- 双重运动，内外开启，90°定位。
- 适用于 8/10/12mm 玻璃
- 小于 85°时门自动关闭，到 25°时起缓冲效果。
- 可选功能

Made Of Precision Cast Stainless Steel.  
Dual Movement, Internal And External Opening, 90° Positioning  
● Suitable For 8/10/12mm Glass  
● Automatic closing from 85° and 85°  
Soft closing from +25° and -25°  
● Optional Functions



产品详细信息 Product Details

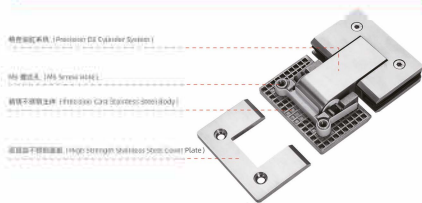

可选标准饰面 (Optional Standard Finishes)

型号 (Model No.)	表面处理 (Finish)
PSS	抛光 Mirror
MBL	哑黑 Matt Black
SSS	拉丝 Satin
TG	钛金 Titanium Gold
RG	玫瑰金 Rose Gold
GM	枪灰 Gun Metal

配置: 垫片 (Gasket)

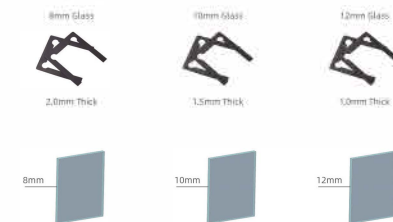

可调 90° 铰链  
Adjustable 90° Hinge

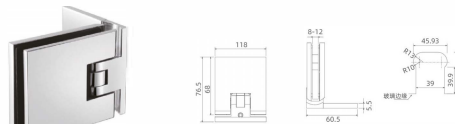

可调 180° 铰链  
Adjustable 180° Hinge

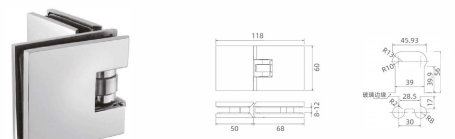

可调铰链 Adjustable Hinge	
应用 (Application)	墙对玻璃 / 玻璃对玻璃 (Wall To Glass/Glass To Glass)
材质 (Material Quality)	精铸不锈钢 (Precision Cast Stainless Steel)
开门动角 (Opening Trend)	双向开门 (Swing Door)
最大门重量 (Maximum Door Weight)	35 公斤 (35kg)
适合门宽度 (Suitable Door Width)	600 毫米 (600mm)
最大开启角度 (Maximum Opening Angle)	90 度 (90°)
适用于钢化玻璃 (Suitable For Tempered Glass)	8-12 毫米 (8-12mm)

型号 (Model)	2 个承重 (Bearing Weight/2 Units)		3 个承重 (Bearing Weight/3 Units)	
	8/10/12mm 玻璃 (Glass)	重量 (公斤) (Weight (kg))	8/10/12mm 钢化 (Glass)	重量 (公斤) (Weight (kg))
	33	33	33	33

产品特点 Product Features

- 由精铸不锈钢制成。
- 双向活动，内外开启。
- 适用于 8/10/12mm 玻璃
- 随意角度锁止定位
- 可选功能

Made Of Precision Cast Stainless Steel.  
Two Way Activities, Internal And External Opening  
● Suitable For 8/10/12mm Glass  
● Lock Positioning At Any Angle  
● Optional Functions



产品详细信息 Product Details

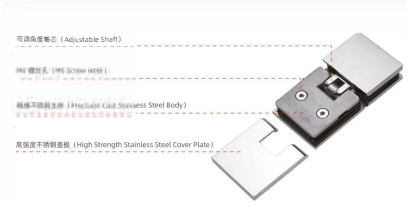

可选标准饰面 (Optional Standard Finishes)

型号 (Model No.)	表面处理 (Finish)
PSS	抛光 Mirror
MBL	哑黑 Matt Black
SSS	拉丝 Satin
TG	钛金 Titanium Gold
RG	玫瑰金 Rose Gold
GM	枪灰 Gun Metal

配置: 垫片 (Gasket)

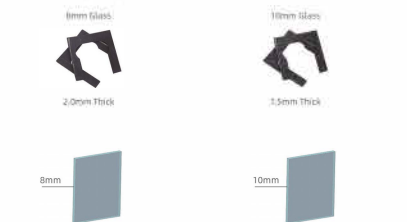

Glass Folding Door Series  
玻璃折叠门系列

安装例图：Installation example:

门条之间 40mm  
玻璃片之间 55mm  
Door strip spacing 40mm  
Glass piece spacing 55mm

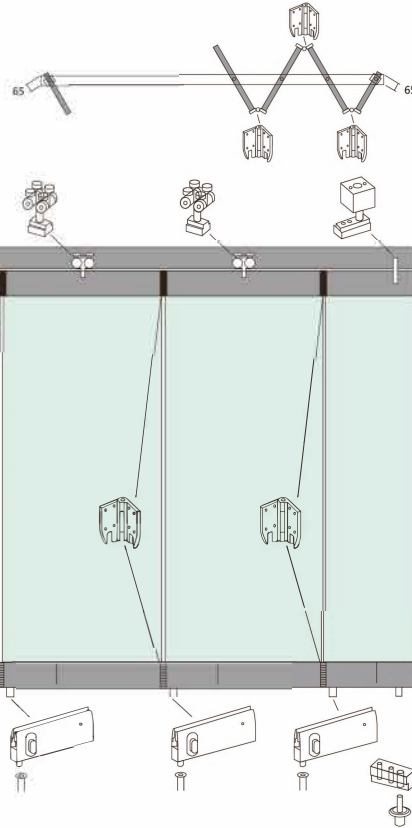

Glass Folding Door Series  
玻璃折叠门系列

表面处理：青古铜 Green bronze 红古铜 Red bronze 钛金 PVD 拉丝金 brushed gold 镜面 mirror 拉丝 satin

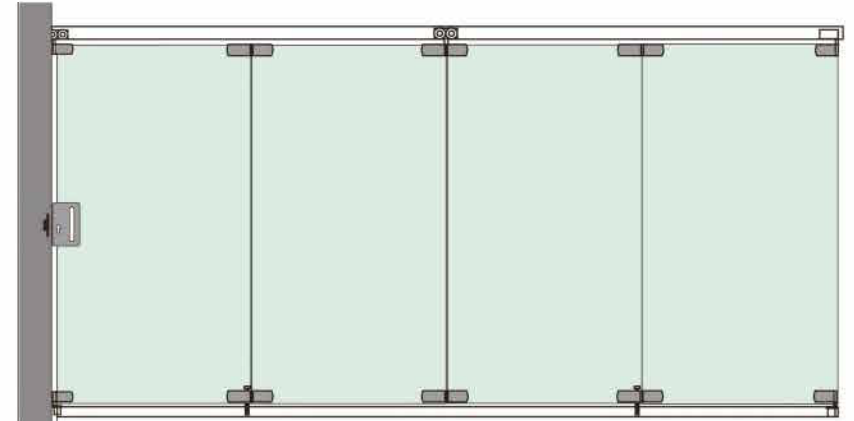

门页最高 Max.door leaf height	2500mm	2500mm	2500mm	2500mm
门页最宽 Max.door leaf width	900mm	900mm	900mm	900mm
最大承重 Max.door leaf load	70kg	70kg	70kg	70kg





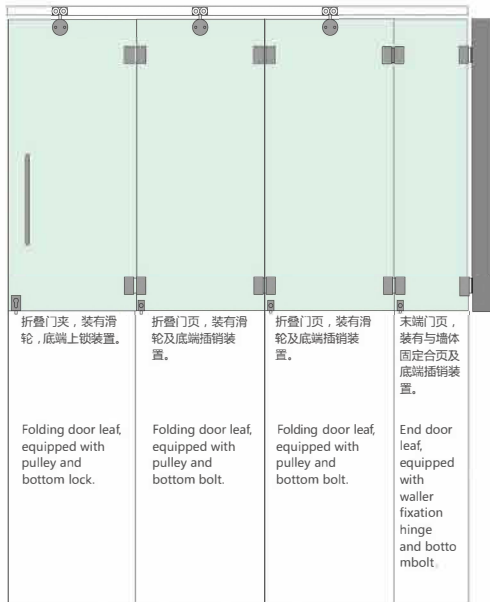

安装例图：  
Installation case diagram:

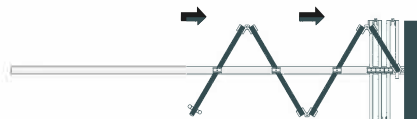

门页最高 Max door leaf height	2500mm	2500mm	2500mm	2500mm
门页最宽 Max door leaf width	900mm	900mm	900mm	1/2 门页 +63mm
最大承重 Max door leaf load	70kg	70kg	70kg	—

产品广泛用于高级宴会厅·大型星级·酒店机场·大型展示厅·各种舞蹈培训室·高级办公场所等...

The products are widely used in the senior banquet hall, large star hotel, airport, large exhibition hall, all kinds of dance training room, high office and so on...



门页最高 Max door leaf height	2800mm	2800mm	2800mm
门页最宽 Max door leaf width	900mm	900mm	1/2 门页 +63mm
最大承重 Max door leaf load	70kg	70kg	—



适用厚度 12mm 钢化玻璃，玻璃需要开孔  
 安装方式：悬中式折叠，顶装

门板最大重量：80KG
门板最大数量：6
玻璃厚度：10mm ~ 12mm
12mm玻璃
门板最大宽度：900mm
门板最大高度：2800mm

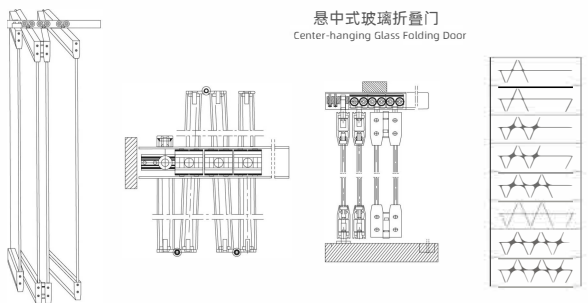
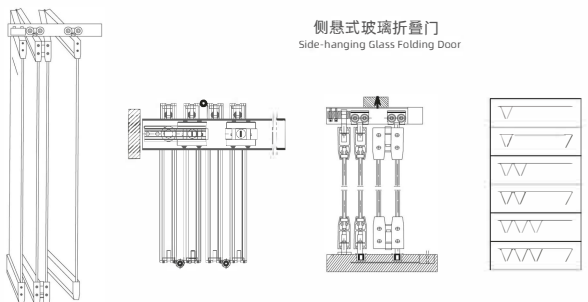
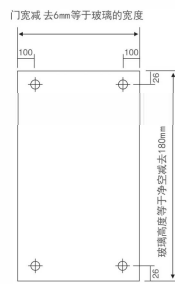

表面处理：青古铜 Green bronze 红古铜 Red bronze PVD 镀金 brushed gold 拉丝金 mirror 镜面 拉丝 satin

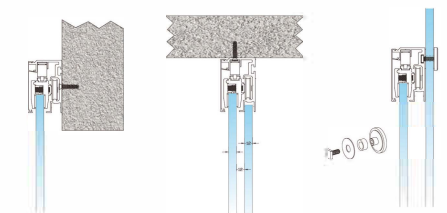
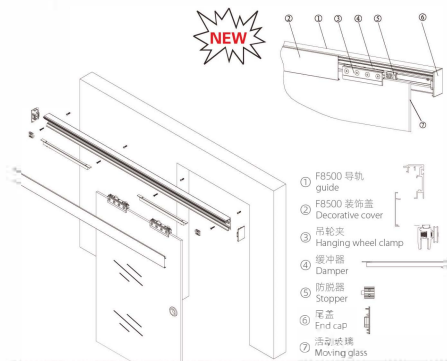

F8500-A1 方式 1: 装在门洞侧面  
 Mode 1: Installed on the side of the doorway

F8500-A2 方式 2: 装在门洞底或天花板  
 Mode 2: Installed under the doorway or ceiling

F8500-A3 方式 3: 装在玻璃上  
 Mode 3: Installed on the glass

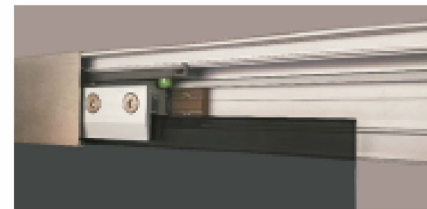

<p>面板 导轨</p> <p>2.2m/2.5m/3m/4.4m/5.5m</p>	<p>凹槽盖</p> <p>2.2m/2.5m/3m/4.4m/5.5m</p>	<p>吊轮夹</p> <p>X2</p>	<p>缓冲杆</p> <p>X2</p>
--	--	----------------------	----------------------

<p>定位器</p> <p>X2</p>	<p>止摆器</p> <p>10/12mm X1</p>	<p>密封盖</p> <p>X2</p>	<p>拉手</p> <p>X1</p>
----------------------	------------------------------	----------------------	---------------------

单向 (无框) | Single Side Opening(Frameless)

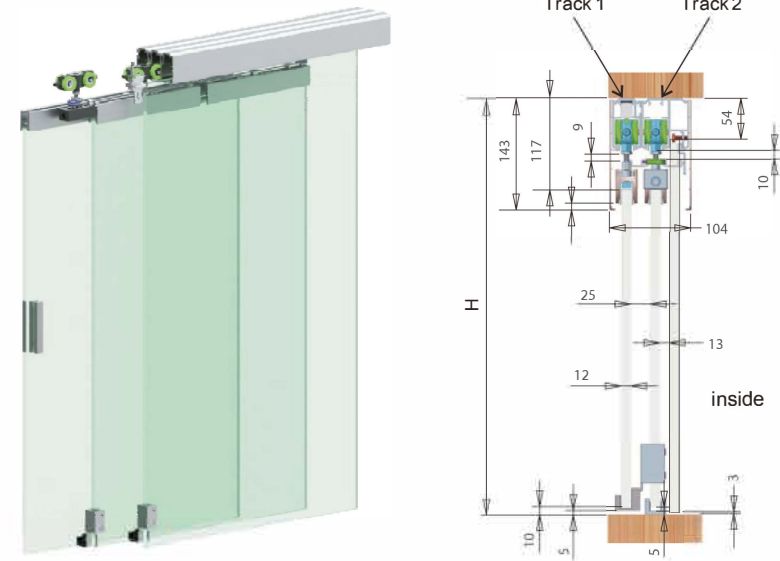

对开 (无框) | Double Side Opening(Frameless)

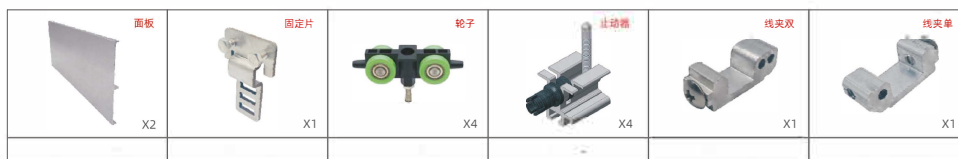
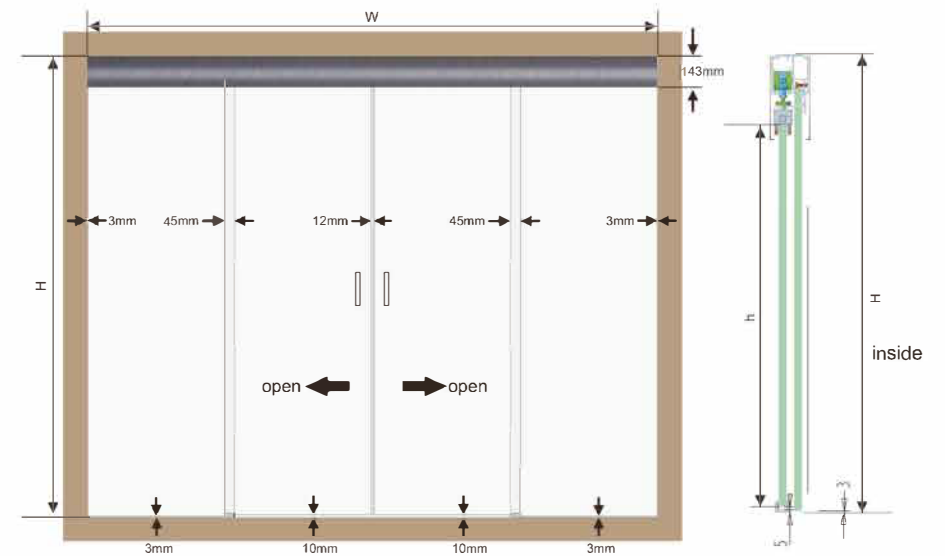

# Soft Close Sliding Door Series

# Soft Close Sliding Door Series

表面处理: FINISH: 青古铜 Green bronze, 红古铜 Red bronze, 镀金 PVD, 拉丝金 brushed gold, 镜面 mirror, 拉丝 satin

### Single Side Opening(Frameless)

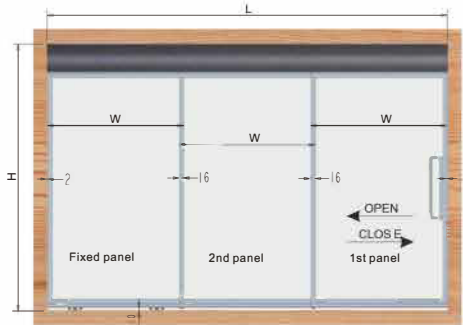

$$W = (L + 16 + 16 - 4) / 3 = (L + 28) / 3$$

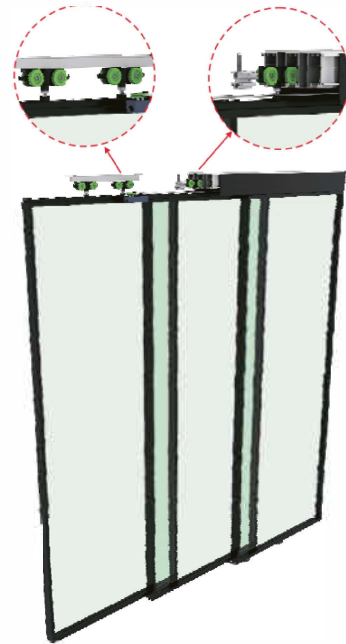
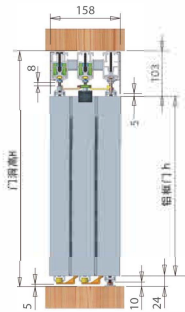

### Double Side Opening(Frameless)

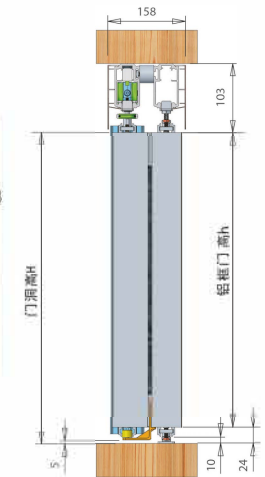
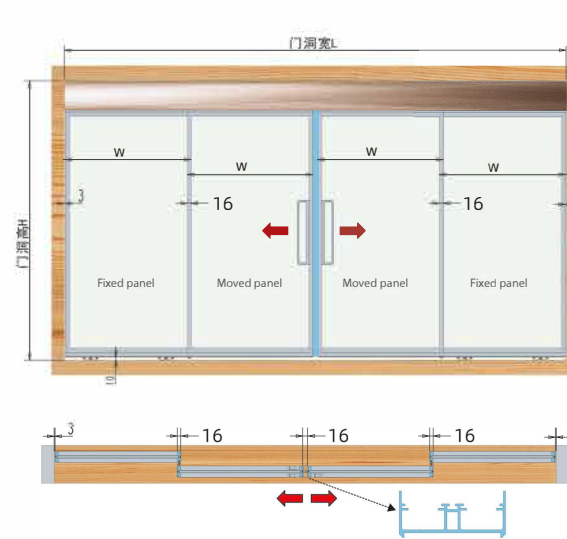

 拉手 选配 X2	 边框 选配	 X1 导轨	 X2 面板	 上下横	 光企	 勾企	 胶条	 X4 轮子
 X4 止动器	 X2 缓冲杆	 X4 吊轮座	 X1 接线座	 X1 接线轮	 X1 拉线器	 X2 活动止壁器		
 X1 定位器	 X2 上固定器	 X2 下固定器	 X2 固定片	 X1 线夹双	 X1 线夹单	 X1 钢丝绳		1.5mmX2.5m

 X2 导轨	 X3 隔块	 X2 面板	 上下横	 光企	 勾企	 胶条	 X4 轮子
 X4 止动器	 X2 缓冲杆	 X4 吊轮座	 X4 上固定器	 X4 下固定器	 X4 固定片		
 X1 定位器	 X1 拉线器	 X2 线轮	 拉手 选配 X2	 边框 选配	 X1 钢丝绳		1.5mmX2.5m

Connectors Integrated Solution

Connectors integrated solution

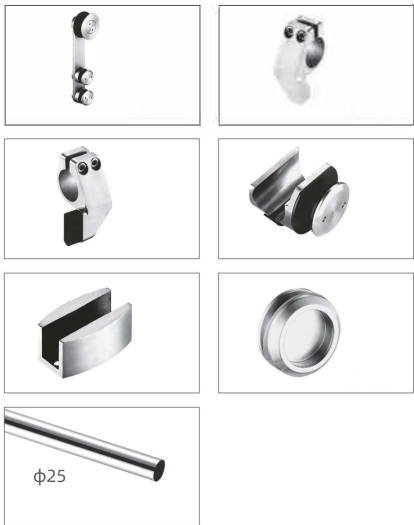

Connectors Integrated Solution

表面处理: 青古铜 Green bronze 红古铜 Red bronze PVD 镀金 brushed gold 镜面 mirror 拉丝 satin

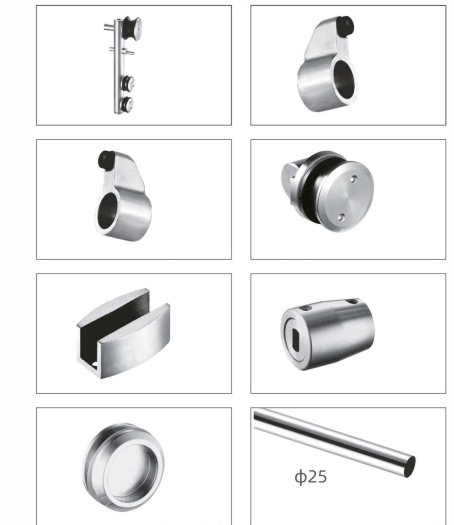

Connectors Integrated Solution



Connectors Integrated Solution

表面处理: 青古铜 红古铜 镀金 拉丝金 镜面 拉丝  
 FINISH: Green bronze Red bronze PVD brushed gold mirror satin

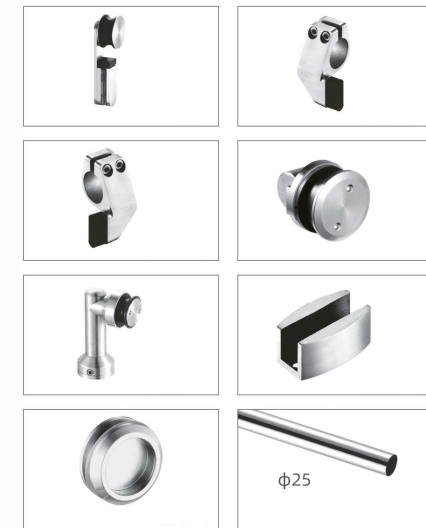

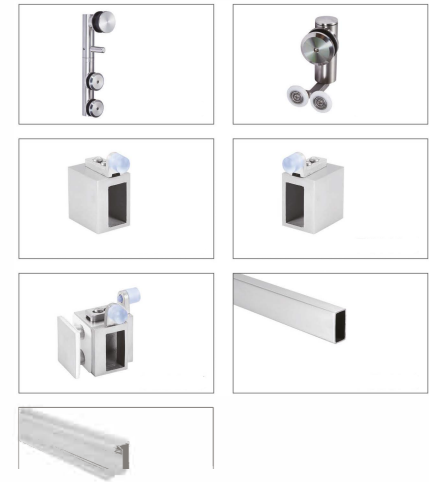

Sliding Door System Series

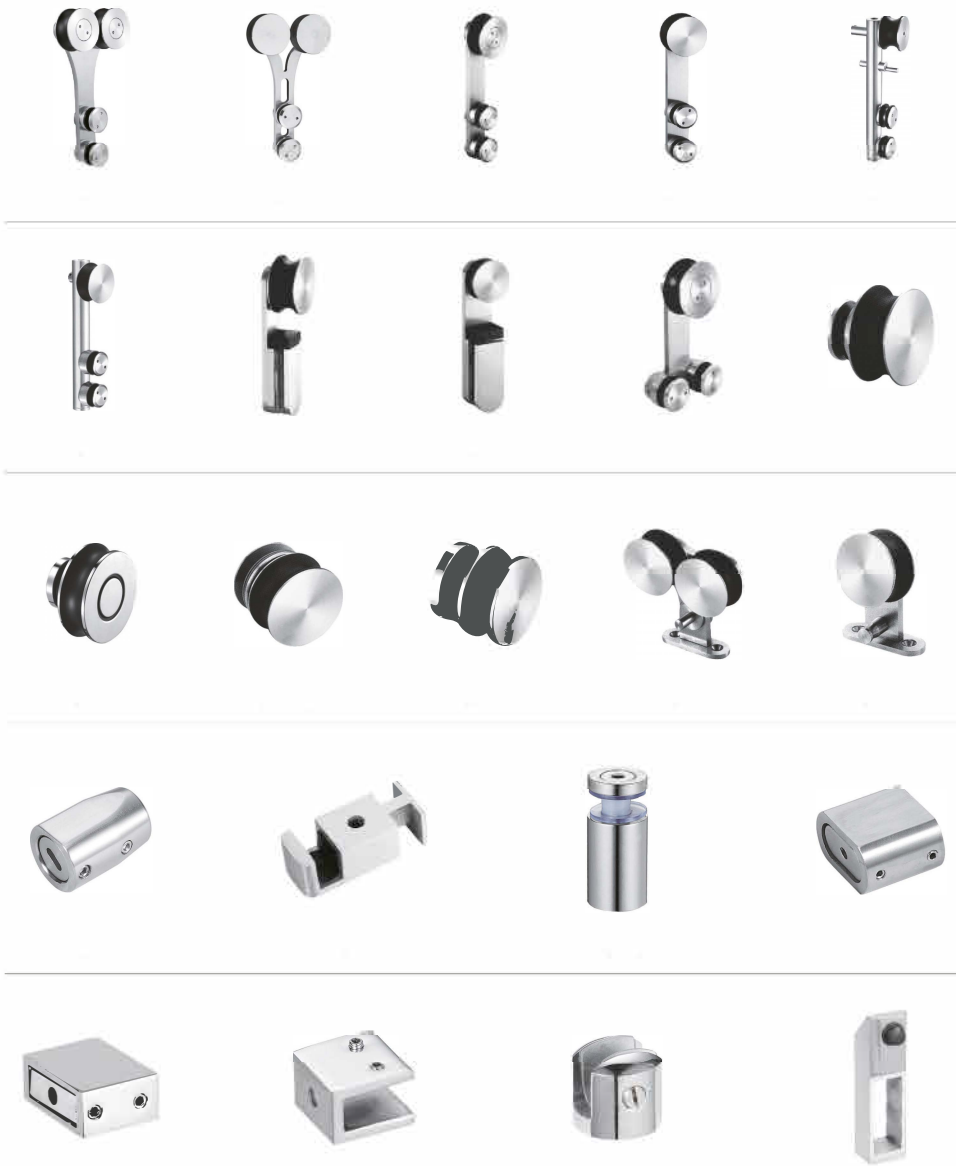

Sliding Door System Series

表面处理: FINISH 青古铜 Green bronze 红古铜 Red bronze PVD 镀金 brushed gold 镜面 mirror 拉丝 satin

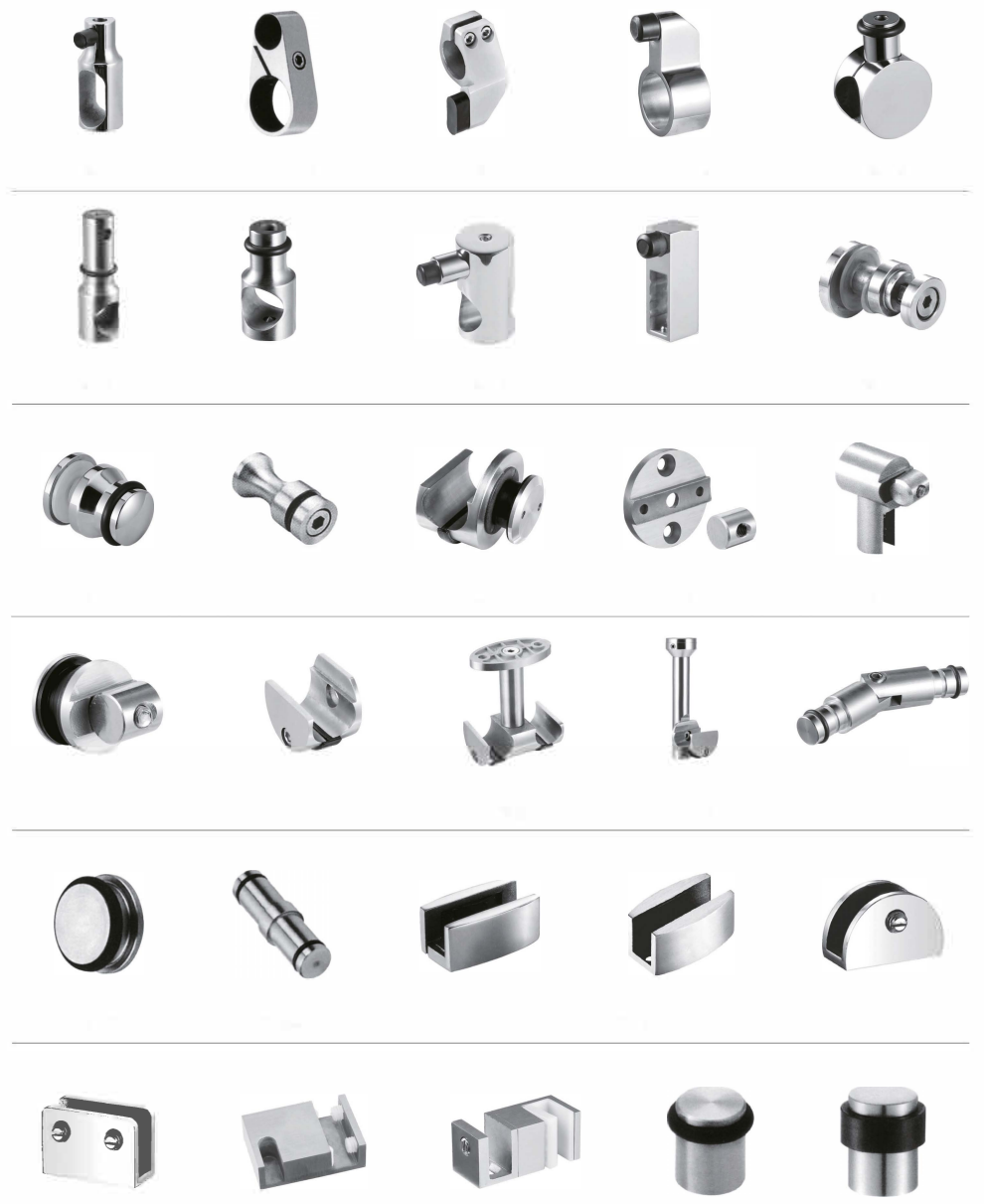



Sliding Door System Series



Glass Connector Series

玻璃连接件系列



Glass Connector Series

表面处理: FINISH: 青古铜 Green bronze 红古铜 Red bronze 镀金 PVD 拉丝金 brushed gold 镜面 mirror 拉丝 satin



Rocking door system series

摇门系列



Sliding Door Hanging Wheel Series



Bathroom Glass Hinge Series  
浴室玻璃铰链系列



Bathroom Glass Hinge Series

室玻 合页系列

表面处理: FINISH 青古铜 Green bronze 红古铜 Red bronze 钛金 PVD 拉丝金 Brushed gold 镜面 Mirror 拉丝 satin



Bathroom Glass Hinge Series  
浴室玻璃合页系列



Bathroom Glass Hinge Series

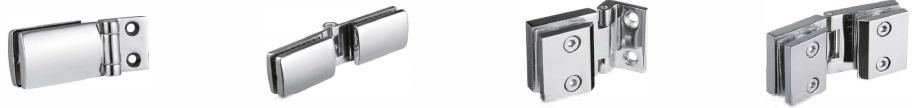

Bathroom Glass Hinge Series

表面处理: 青古铜 红古铜 钛金 拉丝金 镜面 拉丝



Glass Clamp Series  
玻璃夹系列



Glass Clamp Series  
玻璃夹系列

表面处理: FINISH 青古铜 红古铜 钛金 拉丝金 镜面 拉丝



The Bathroom Lock Series  
浴室锁系列



Glass Shaft Series  
玻璃转轴系列



Swimming Pool Accessories Series  
泳池配件系列



Shower Rod Series  
淋浴房拉杆系列

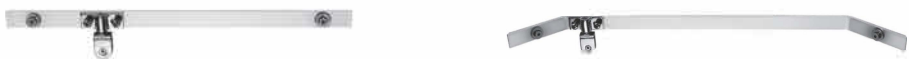

Shower Rod Series  
淋浴房拉杆系列

表面处理: FINISH 青古铜 红古铜 钛金 拉丝金 镜面 拉丝



Bathroom Connector Series  
浴室连接件系列



Bathroom Connector Series  
浴室连接件系列

表面处理: 青古铜 紅古铜 鎊金 拉丝金 镜面 拉丝  
FINISH: Dark Bronze Red Bronze Gold Plated Brushed Gold Mirror Polished Wire Mesh

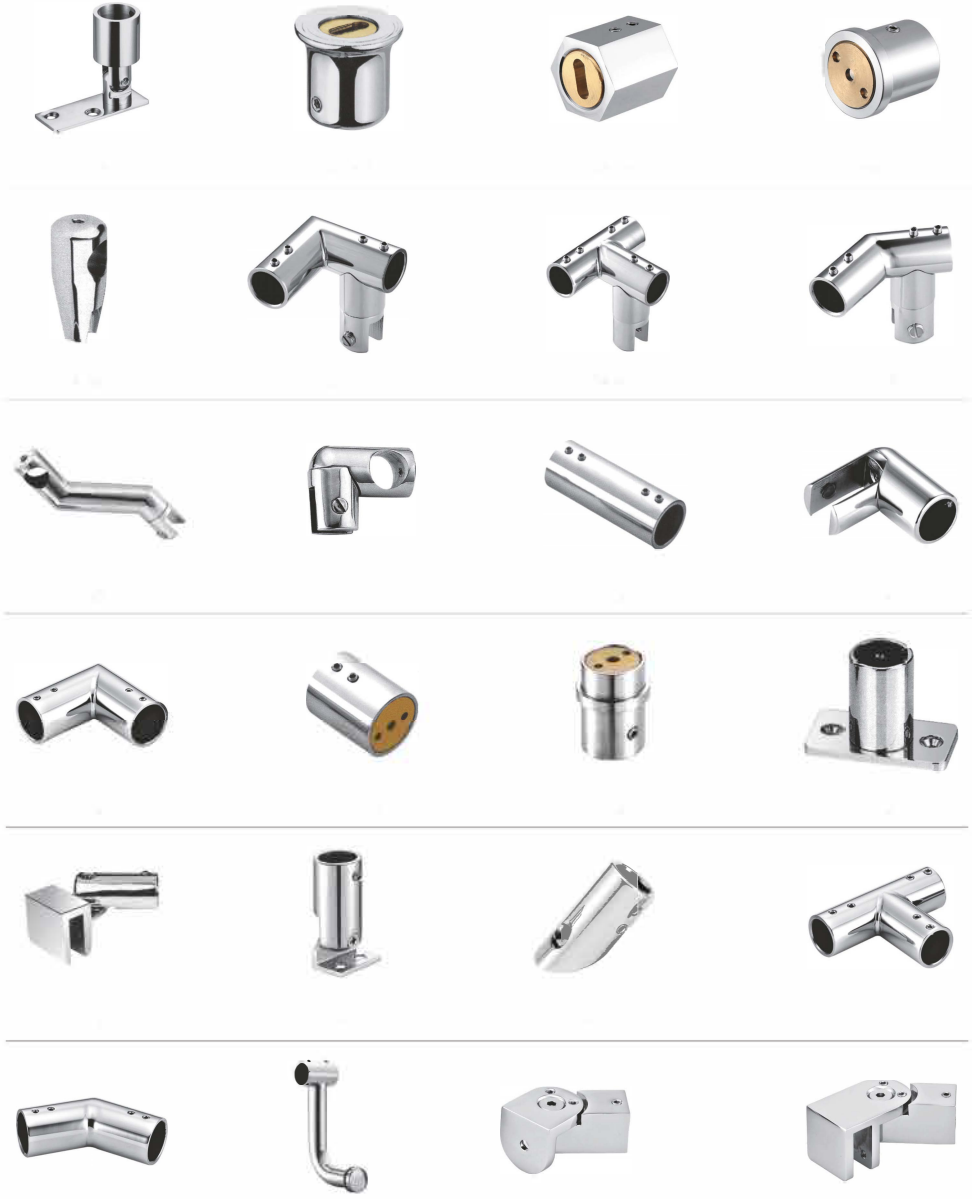

Bathroom Connector Series  
浴室连接件系列

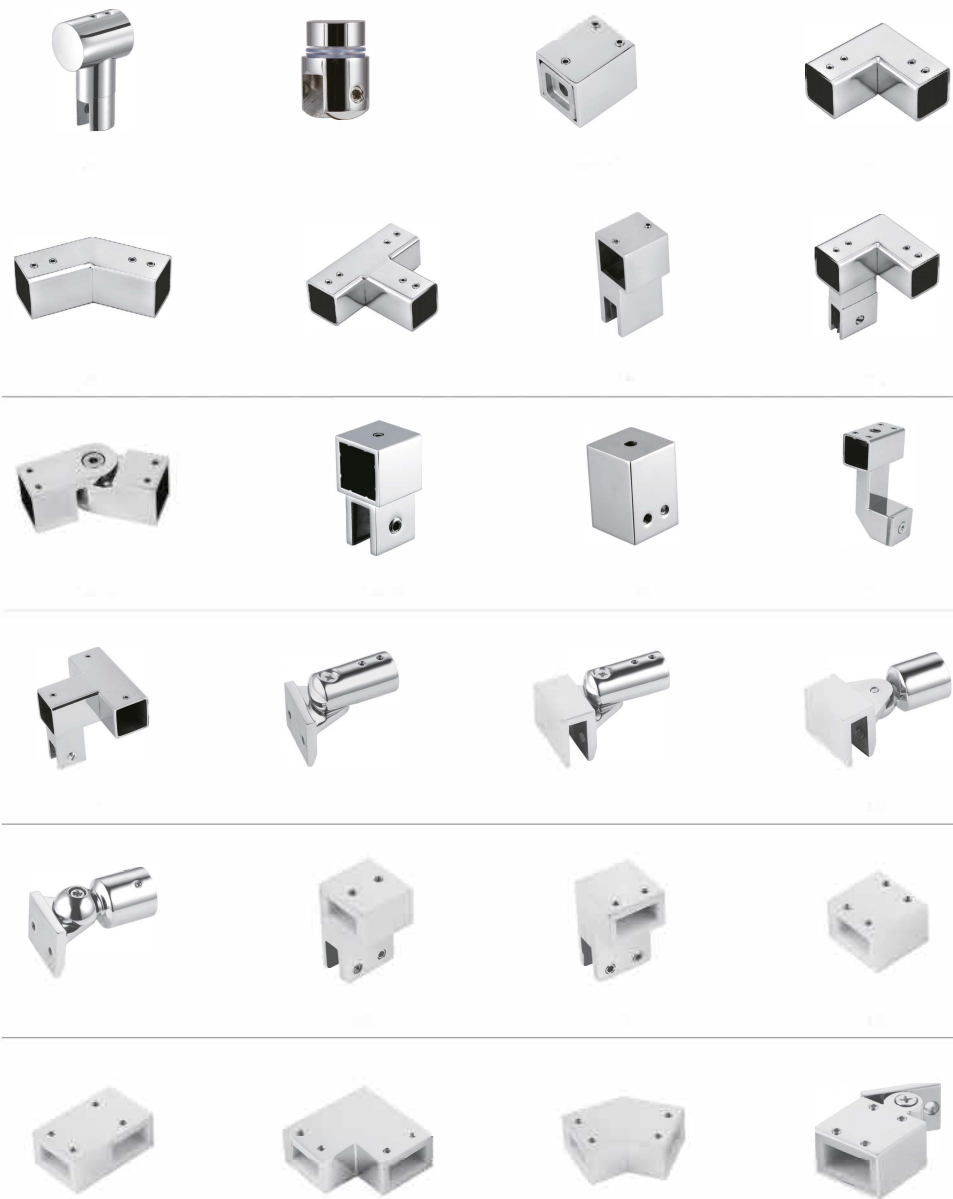

Door Handle Series  
门拉手系列

表面处理: 青古铜 红古铜 钛金 拉丝金 镜面 拉丝  
FINISH: 青古铜 红古铜 钛金 拉丝金 镜面 拉丝

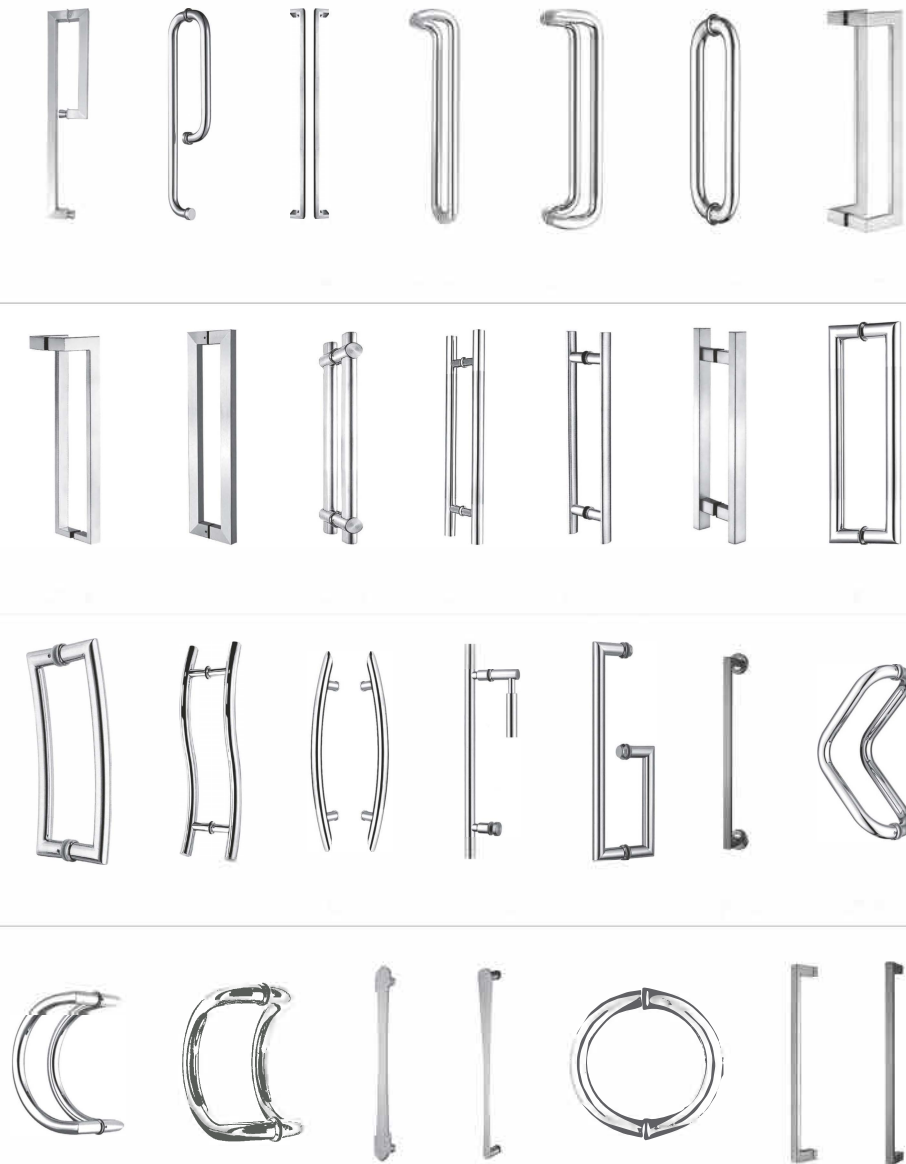

Door Handle Series  
门拉手系列



Door Handle Series  
门拉手系列

表面处理: FINISH 青古铜 红古铜 钛金 拉丝金 镜面 拉丝





Translucent Sealing Strips Series  
封边条系列



DOOR HANDLE SERIES  
门拉手系列



Furniture Handle Series  
小拉手系列

表面处理: FINISH 青古铜 红古铜 钛金 拉丝金 镜面 拉丝



Translucent Sealing Strips Series  
 玻1离门夹系列

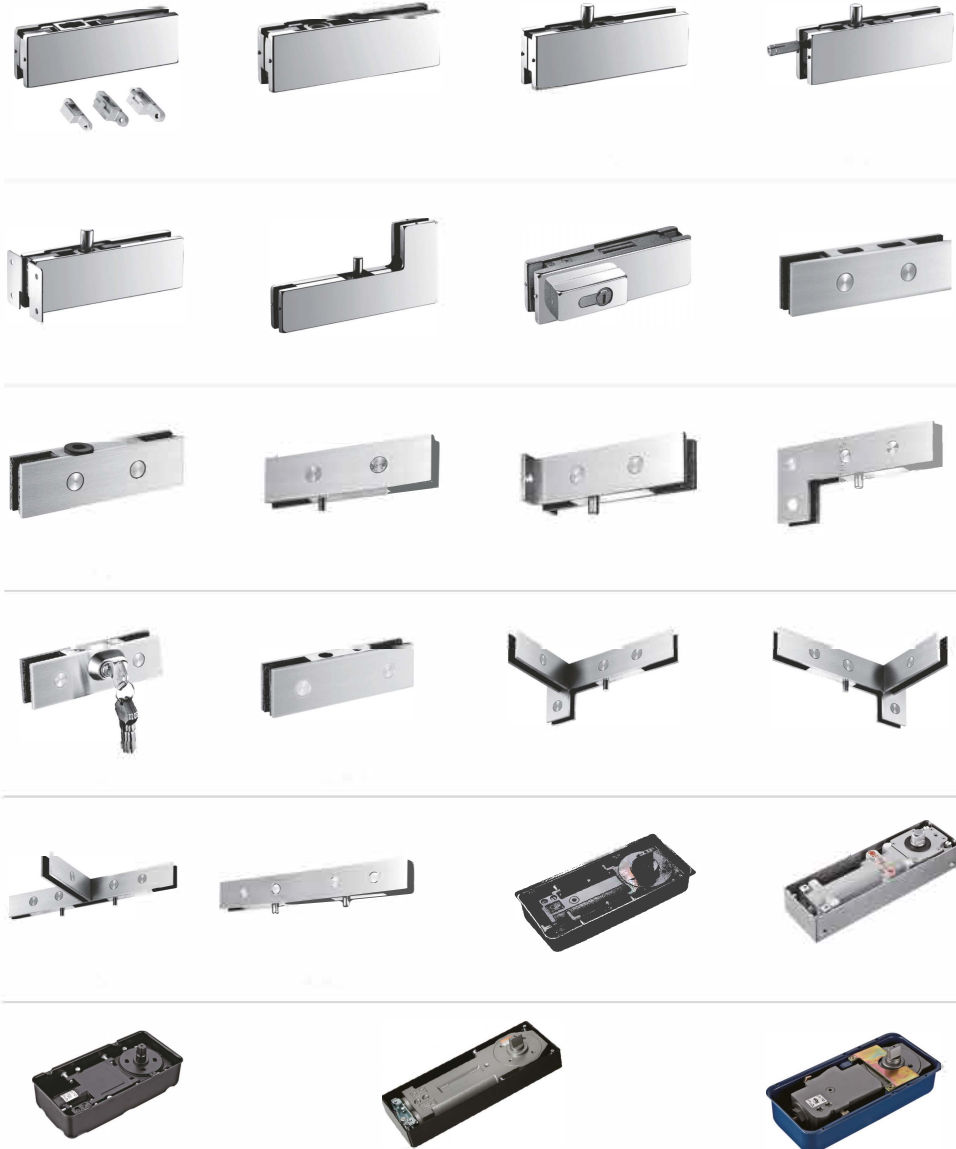

Floor Spring Series  
 地 弹簧 系

表面处理: 青古铜 红古铜 钛金 拉丝金 镜面 拉丝



Door Closer Series  
 闭门器系列



Wooden Door Hinge Series  
 木门合页系列

