

Outdoor Fences Catalog

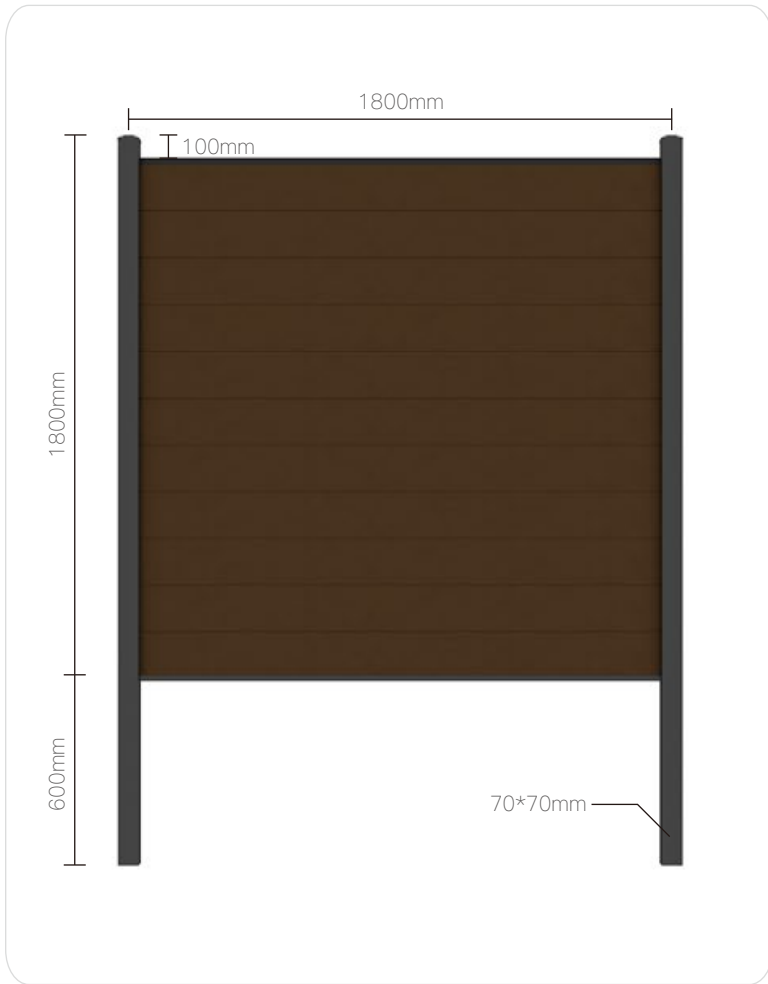

FENCE

MEASUREMENT



COMPONENTS

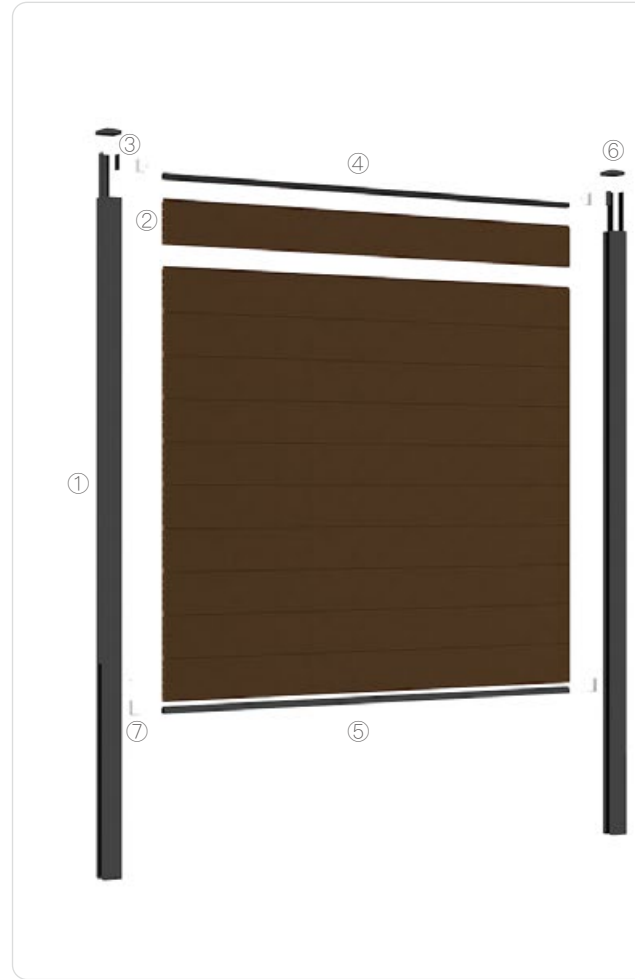

① Aluminum Post
(70x70x2400mm)



② Fencing Board
(158x20x1735mm)



③ Aluminum Sealing Edge
(25x7x2400mm)



④ (21x20x1740mm)



⑤ Aluminum Fence Base
(26x20x1740mm)



⑥ Post Cap
(70x70mm)

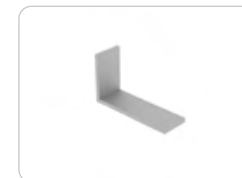

⑦ L-Clip
(52x30mm)

FENCE

MEASUREMENT

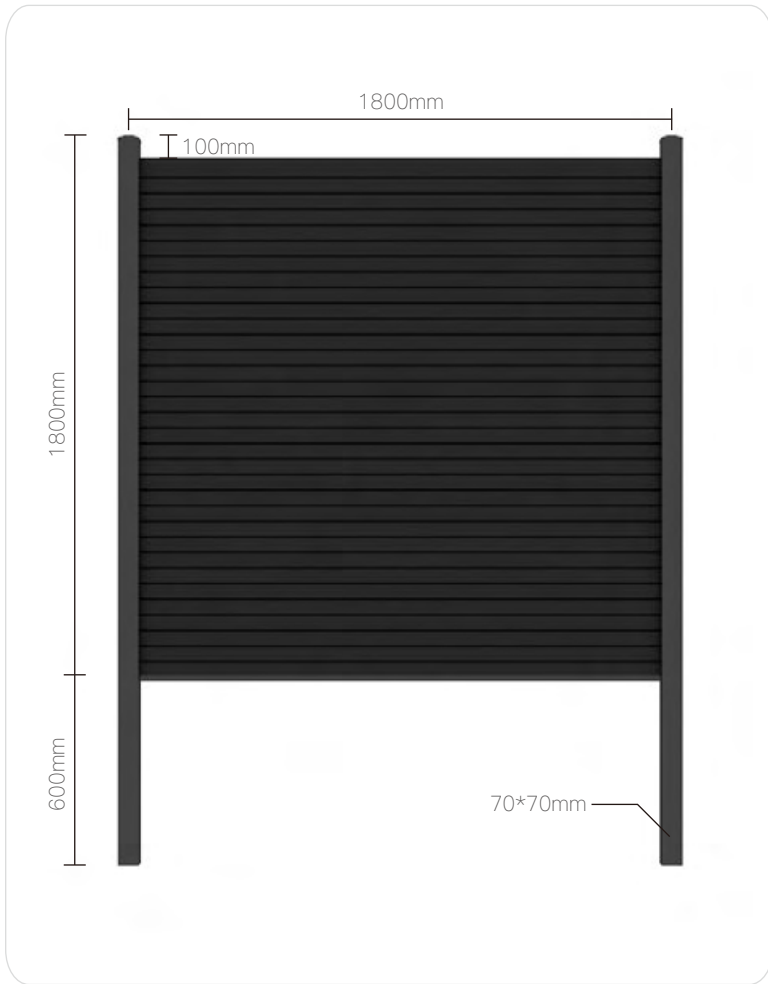

COMPONENTS

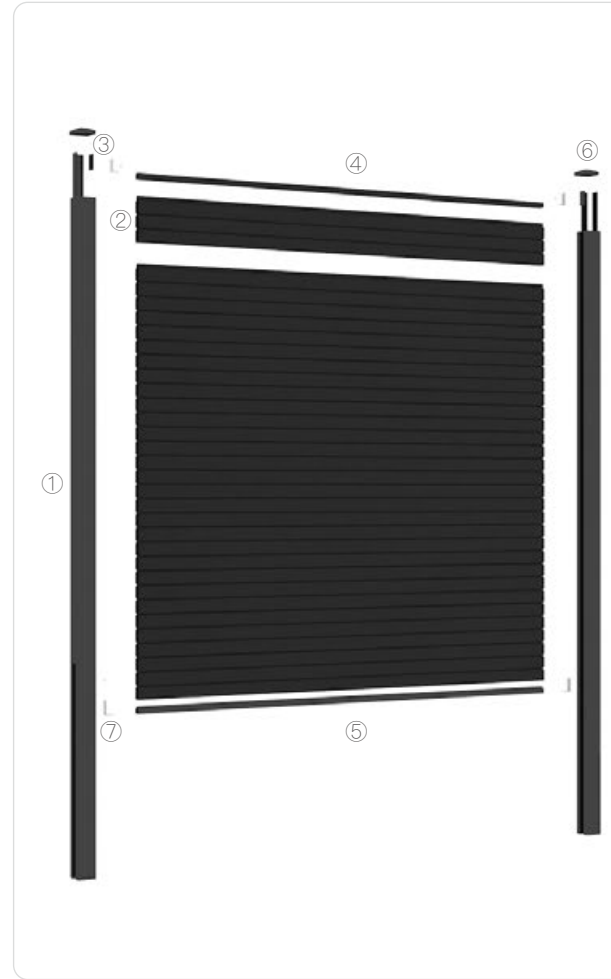

① Aluminum Post
(70x70x2400mm)

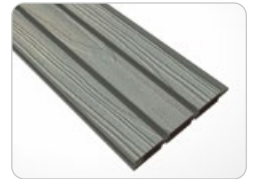

② Fencing Board
(165x20x1735mm)

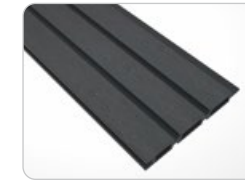

② Fencing Board
(165x20x1735mm)



③ Aluminum Sealing Edge
(25x7x2400mm)



(21x20x1740mm)



⑤ Aluminum Fence Base
(26x20x1740mm)



⑥ Post Cap
(70x70mm)

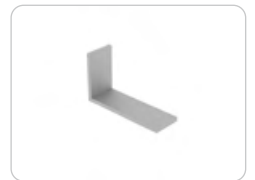

⑦ L-Clip
(52x30mm)

FENCE G

MEASUREMENT

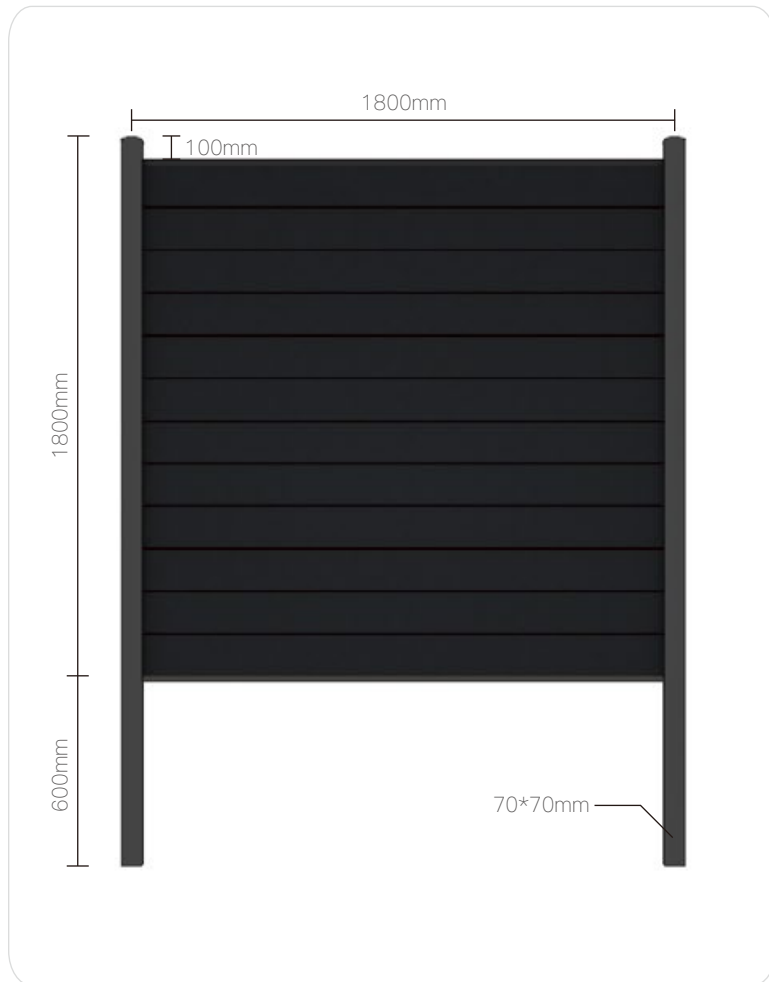

COMPONENTS

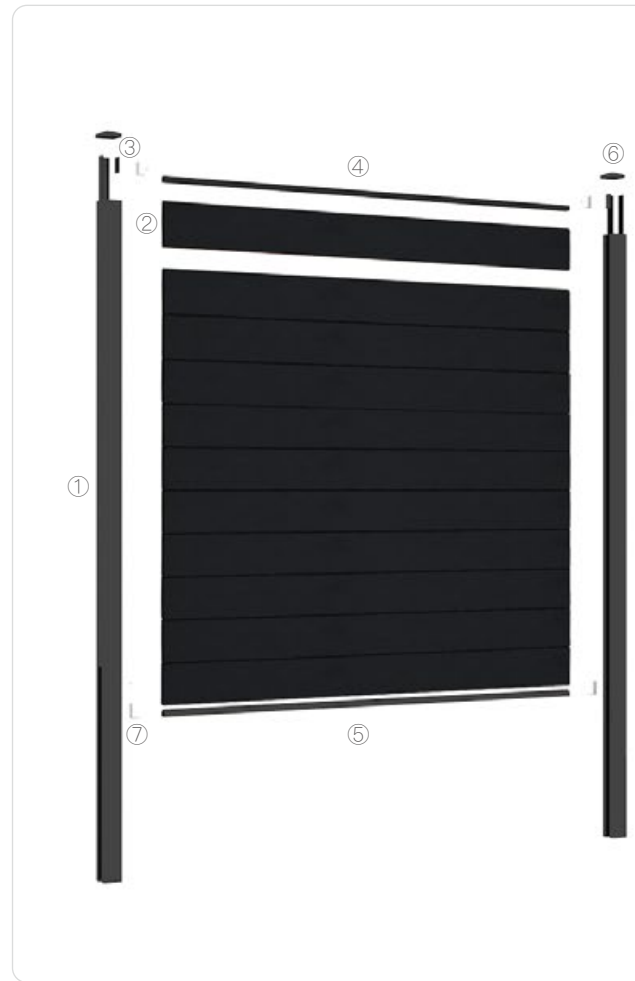

① Aluminum Post
(70x70x2400mm)



② Fencing Board
(150x20mm)



③ Aluminum Sealing Edge
(25x7x2400mm)



④ (21x20x1740mm)



⑤ Aluminum Fence Base
(26x20x1740mm)



⑥ Post Cap
(70x70mm)

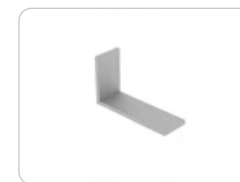

⑦ L-Clip
(52x30mm)

FENCE

◆ INSTALLATION STEPS

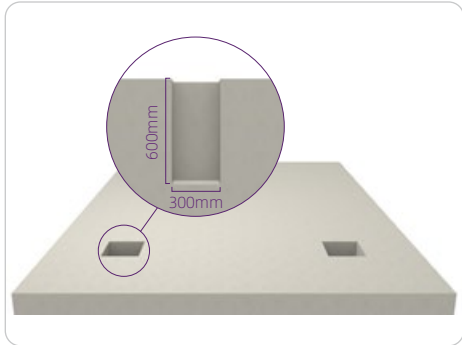

1. Dig Holes

Dig a 300mm diameter hole in the ground with a depth of min 600 mm (or follow local practice), and make sure they're properly spaced. The spacing between posts on-center should be 1.8 meters.

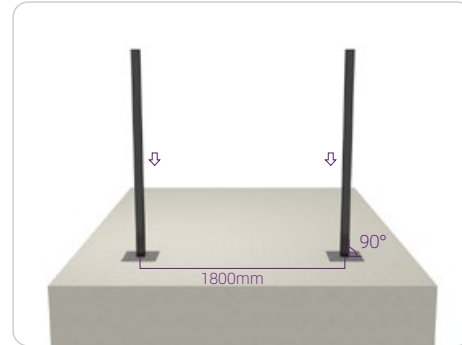

2. Set Posts

Place posts into the holes. Pour in concrete and wait for it to set. Make sure the posts are plumb and in a straight line.

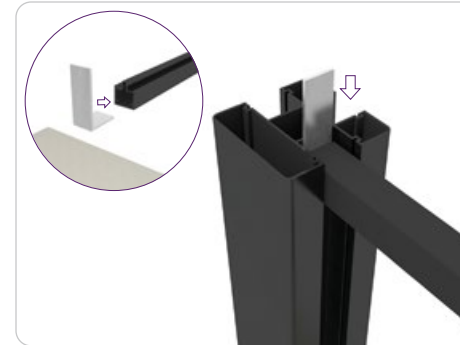

3. Push In Aluminum Fence Base

Attach L-clips to each end of the aluminum fence base and push them down to the bottom.

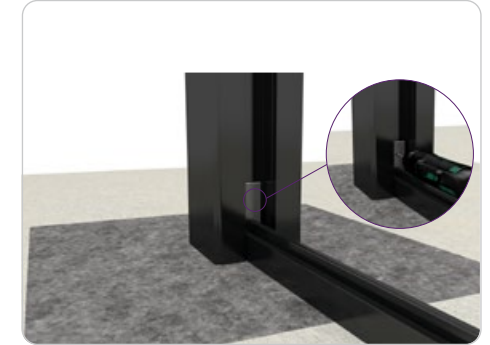

4. Secure L-clips

Fix L-clips to the post with self-drilling screws.

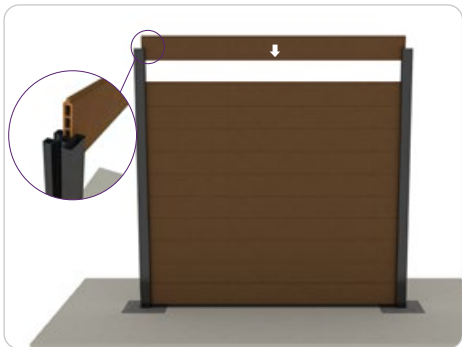

5. Slide in Fence Boards

Place into position fence boards one by one.

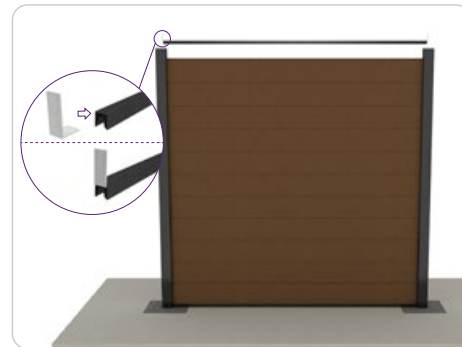

6. Install Top Fence Board

Attach L-clips to each end of the top fence board and put them into position. Fix L-clips to the post with self-drilling screws.

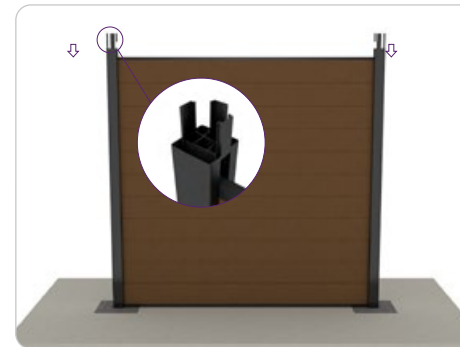

7. Fix the Sealing Edges

Slide in sealing edges.



8. Installation Finished

Put on post caps. Installation finished.

FENCE FENCING

◆ PROJECT CASE



◆ AVAILABLE COLORS



Smoke Gray



Oak

◆ PROJECT CASE



◆ AVAILABLE COLORS



Smoke Gray



Black

◆ AVAILABLE COLORS



Red Pine



Coffee



Blue Gray

FENCE

MEASUREMENT



MATCHING FENCE GATE



Single-Gate
(W1100 × H1800mm)



Double-Gate
(W3200 × H2000mm)

FENCE G

◆ COMPONENTS



① WPC Post
(100×100mm)



① WPC Post
(140×140mm)



② Fencing Board
(150×20mm)



③ Top Fence Board
(140×20mm)



④ Metal Post Base
40×40mm

OR



④ Metal Post
40×40mm



④ Metal Post Base
(h1500*φ74mm)

OR

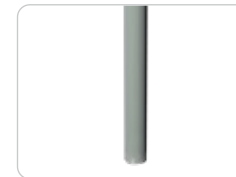

④ Metal Post
φ75mm



⑤ Aluminum Fence Base
(20×26mm)



⑥ WPC Sealing Edge
(26.2×20mm)



⑦ WPC Post Cap
120×120mm



⑦ Post Cap
140×140mm

FENCE

◆ POST WITH STEEL BASE INSTALLATIONS

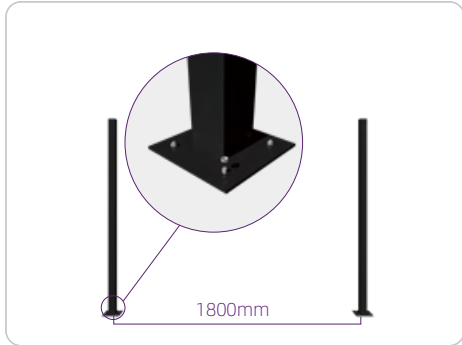

1. Fix Steel Bases

Determine the position of the fence posts, anchor the steel bases to the ground with SS expansion bolts.

Note: Keep the fence posts in a straight line.



2. Set Posts

Slide posts over the steel bases.

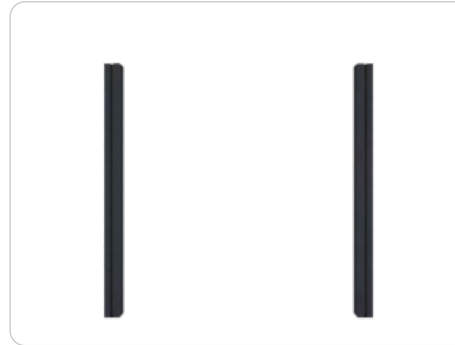

◆ POST PRE-BURIED STEEL TUBE INSTALLATIONS

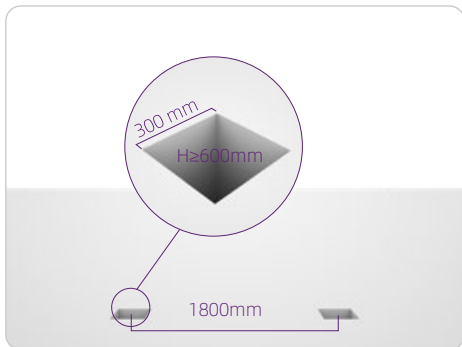

1. Dig Holes

Dig a 300mm diameters' hole in the ground with a depth of min 600 mm (or follow local practice), and make sure they're properly spaced. The spacing between posts on-center should be 1.8 meters.

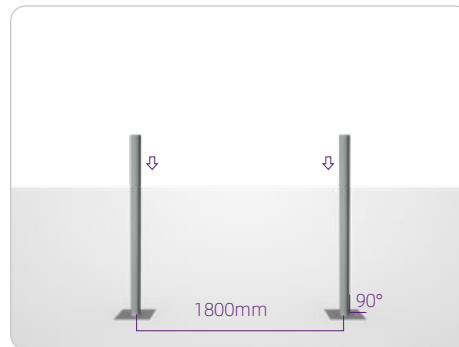

2. Set Steel Tubes

Place steel tubes into the holes. Pour in concrete and wait for it to set. Make sure the posts are plumb and in a straight line.



3. Set Posts

Slide posts over the steel tubes.



4. Slide in Plastic Clips

Slide plastic clips into the post slots. Make sure the clips at the bottom of the two posts are flush with each other and in the correct position by using a level. Fix the plastic clips to the posts with self-drilling screws.

FENCE G

◆ INSTALLATION STEPS

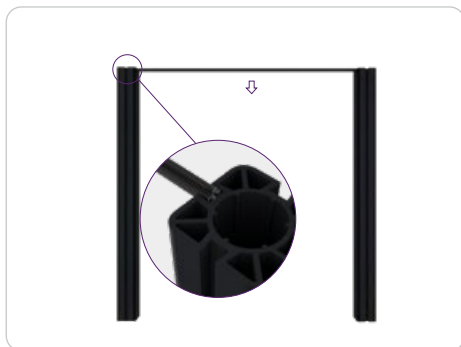

1. Fix the Aluminum Fence Base

Place the aluminum fence base on the bottom along the groove of the post.

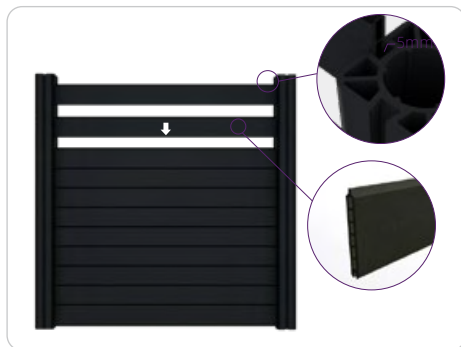

2. Slide in Fence Boards

Push the fence boards in one by one along the slots of the posts.

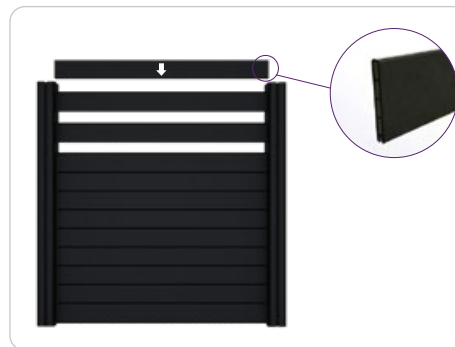

3. Place Top Board into Place

Place the Top Fence Board on top.



4. Keep a gap

Keep an overall gap of 5 mm between the board ends and the post slots.

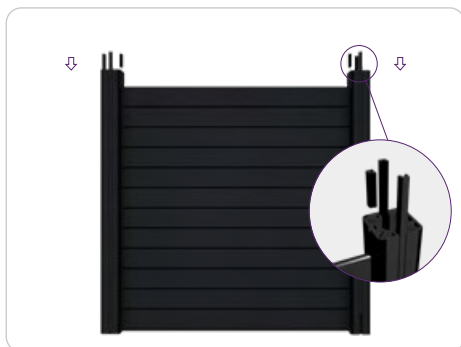

5. Slot in Sealing Strips

Slot the sealing strips into the posts.



6. Put on Post Caps

Put post caps on the posts.



7. Installation Finished

Continue and finish the installation in the same manner.



FENCE

◆ PROJECT CASE



◆ AVAILABLE COLORS



Red Pine



Coffee



Blue Gray

FENCE GATE

MEASUREMENT

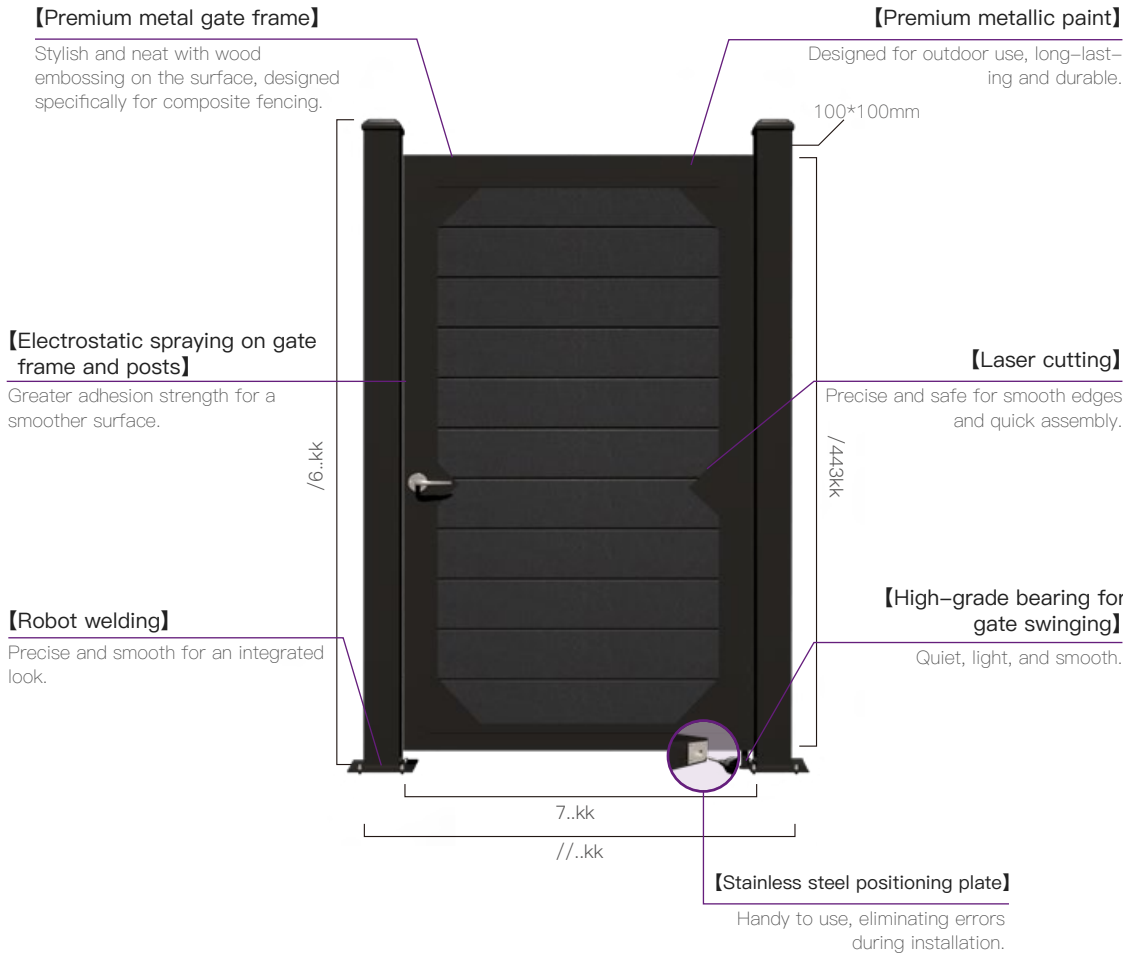

COMPONENTS

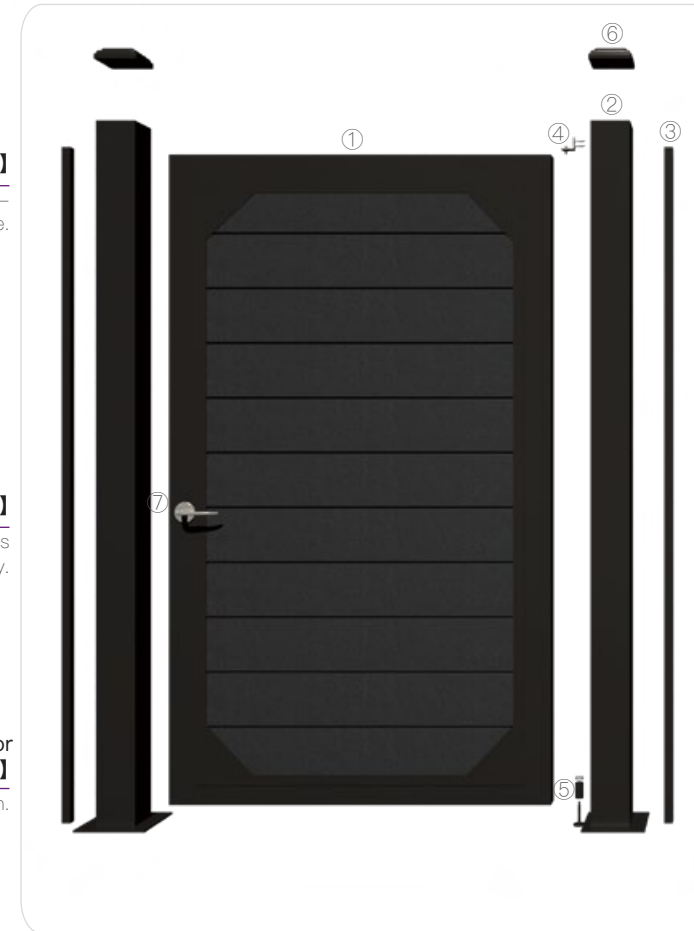

① Fence Gate (1665x900mm)



② Metal Post Base (h1800*φ100mm)



③ U-Slot (1700x20x20mm)



④ L-Hinge



⑦ Latch Protector



⑥ Aluminum Cap (100x100mm)



⑤ Bearing

◆ Fence Gate Installation

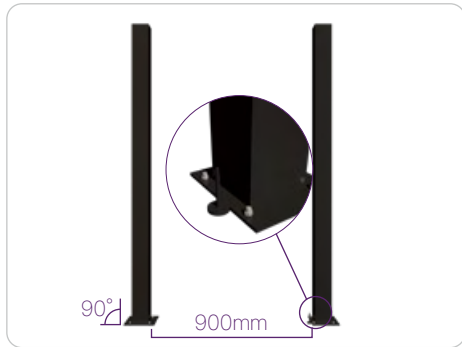

1. Set Posts

Prior to installation, make sure the ground is solid and smooth. Determine the swing direction of the fence gate. Anchor the fence gate posts to the ground with expansion bolts.

Note: Keep a distance of 900 mm between the sides of the posts and make sure they're plumb and in a straight line.



2. Install Bearing Pedestal and Bearing

Put the bearing pedestal and bearing on the pin.

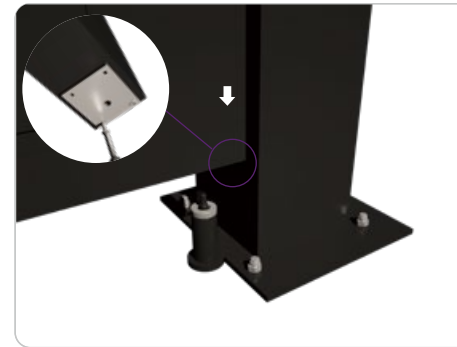

3. Fix Shim to Gate

Fix the shim with screws over the hole on the bottom of the gate, make sure the shim is well centered. Mount the gate onto the pin.

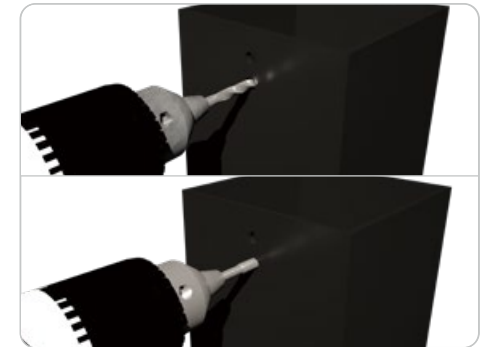

4. Drill and Tap Holes

Use the gate to determine the position of the upper L-hinge, then drill and tap the holes for the L-hinge.



5. Fix L-Hinge to Post

Fix the L-hinge to the post with machine screws, and tighten the nuts from inside the post.



6. Gate Placement

Secure the L-hinge to the gate with a hexagon socket bolt.



7. Gate Placement Finished

Gate placement completed.



8. Fix Strike Plate and Latch Protector

Fix the strike plate and latch protector to the post with self-drilling screws, and make sure it's in the correct position so that the lock functions well.

◆ Fence Installation

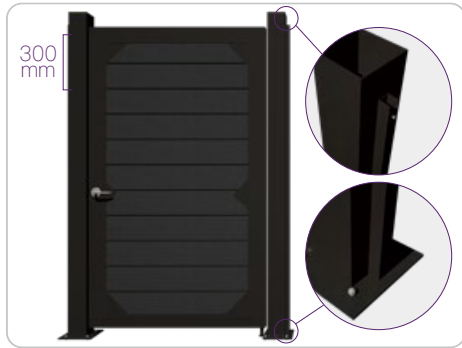

9. Fix U-Slots to Fence Gate Post

Place U-slots on the side of the fence gate post where fence boards are installed, make sure they're centered, then fix with screws at an interval of 30 cm.

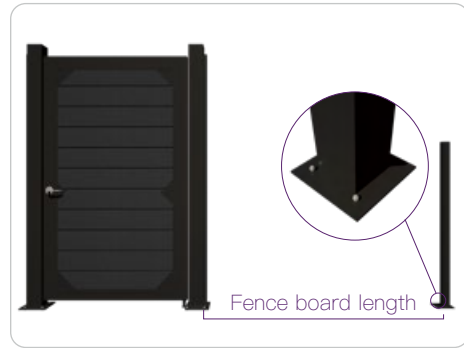

10. Install Fence Post

Determine the position of the fence posts, anchor the steel base to the ground with SS expansion bolts, and slide the fence post over the steel base.

Note: Make sure the fence posts are in a straight line.



11. Set Posts

Put the post on the steel base.

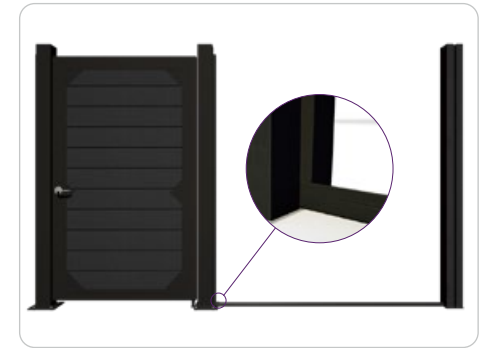

12. Fix the Aluminum Fence Base

Slide an aluminum fence base to the bottom along the slots of the post.

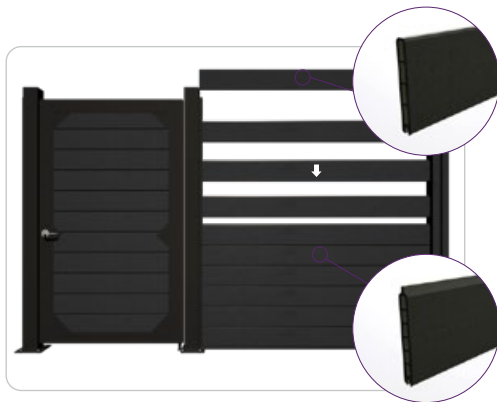

13. Install Fence Boards

Push in the fence boards one by one along the slots of the posts, and the Top Fence Board should be last.

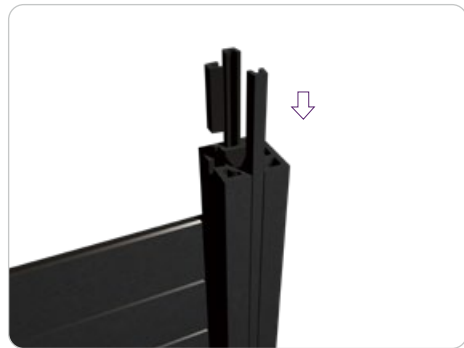

14. Insert Sealing Strips

Fence installation completed, Insert sealing strips into the posts.



15. Put on Post Caps

Put the post cap on the top of the post.



16. Installation Finished

Continue with other fence installations. Installation finished.

FENCE GATE

MEASUREMENT

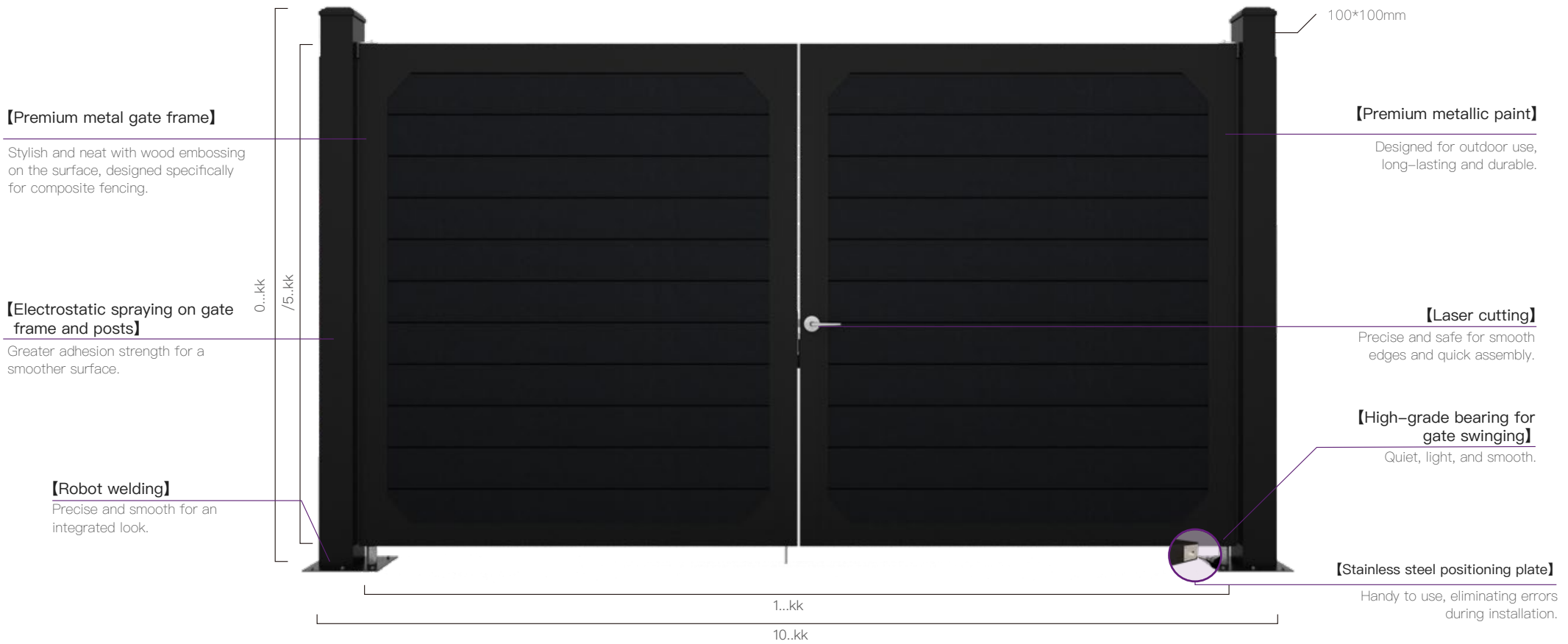

FENCE GATE

COMPONENTS

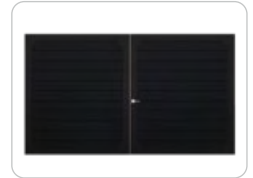

① Fence Gate
(3000x1700mm)



② Metal Post Base
(h2000*100*100mm)



③ U-Slot
(1700x20x20mm)



④ L-Hinge



⑦ Latch Vertically



⑥ Aluminum Cap
(100x100mm)



⑤ Bearing

◆ Fence Gate Installation

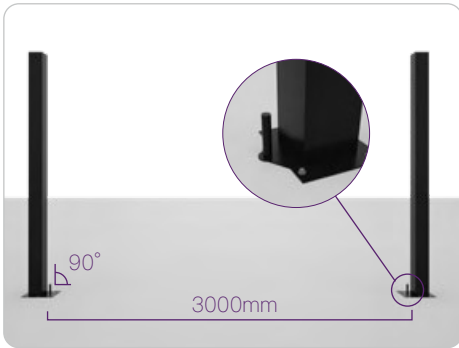

1. Set Posts

Before installation, make sure the ground is smooth and solid. Determine the swing direction of the gate. Anchor fence gate posts to the ground with expansion bolts.

Note: Keep a distance of 3000 mm between two posts and make sure they're in a straight line.

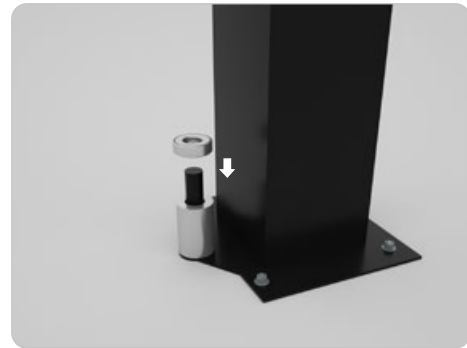

2. Install Bearing Pedestal and Bearing

Put the bearing pedestal and bearing on the shaft.

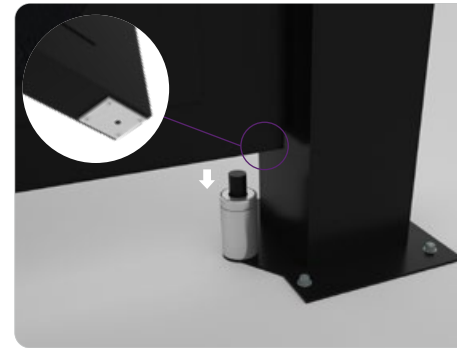

3. Fix Shim to Gate

Fix the shim with screws over the hole on the bottom of the gate, make sure the shim is well centered.

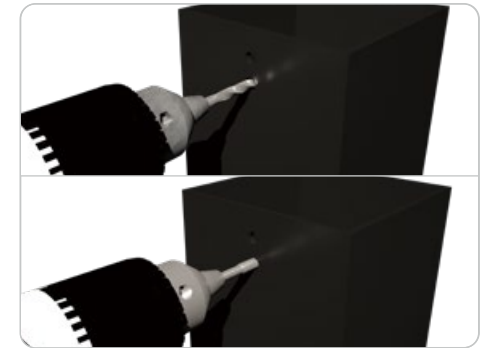

4. Drill and Tap Holes

Mount the gate to the post and then drill and tap the holes for the L-hinge.



5. Fix L-Hinge to Post

Fix the L-hinge to the post with machine screws, and tighten the nuts from inside the post.



6. Gate Placement

Secure the gate in place with a machine screw going through the L-hinge.

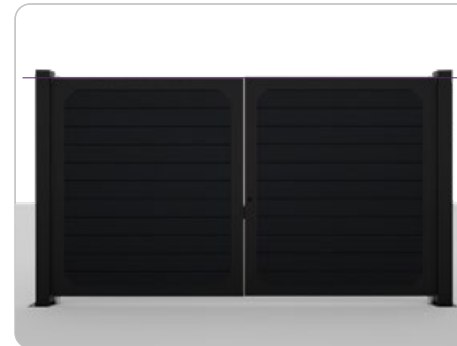

7. Gate Placement Finished

Make sure the left and right sides are aligned and the gaps are uniform. You can make adjustments by adding or reducing shims.

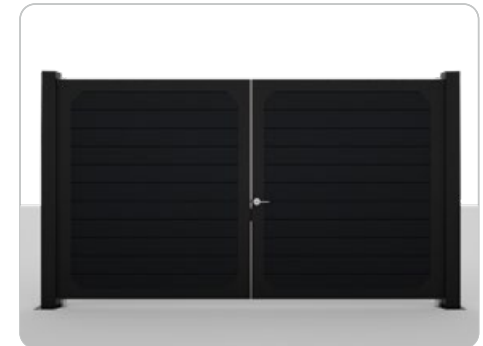

8. Install the lock

Fix the lock to the gate, and make sure it's in the correct position so that the lock functions well.

◆ Fence Gate Installation

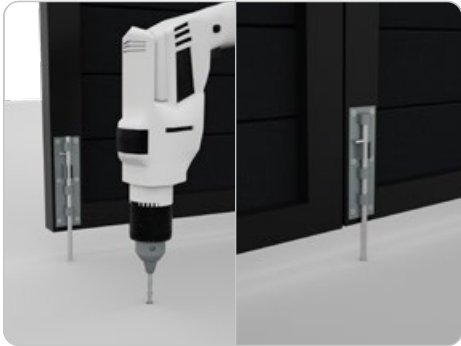

9. Fix Latch Vertically

With respect to the ground clearance, at the bottom of the gate, secure the latch vertically in position with self-drilling screws. Drill a hole 5 mm in depth and 16 mm in diameter on the ground to accommodate the latch bolt when locking the gate.

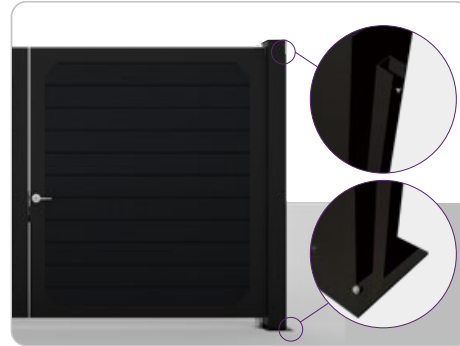

10. Fix U-Slots to Fence Gate Post

Place U-slots on the side of the fence gate post where fence boards are installed, make sure they're centered, then fix with screws at an interval of 30 cm.

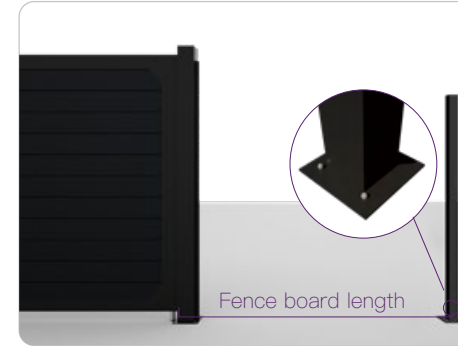

11. Set Posts

Put the post on the steel base.



12. Fix the Aluminum Fence Base

Slide an aluminum fence base to the bottom along the slots of the post.

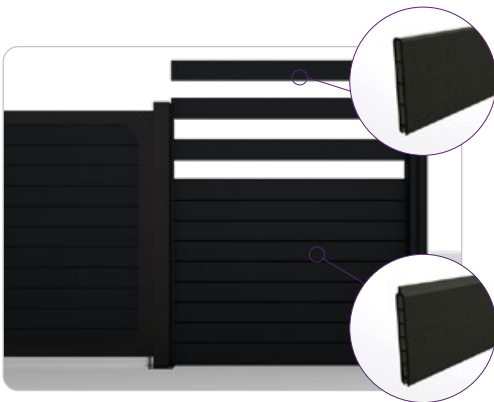

13. Install Fence Boards

Push in the fence boards one by one along the slots of the posts, and the Top Fence Board should be last.



14. Insert Sealing Strips

Fence installation completed, Insert sealing strips into the posts.



15. Put on Post Caps

Put the post cap on the top of the post.

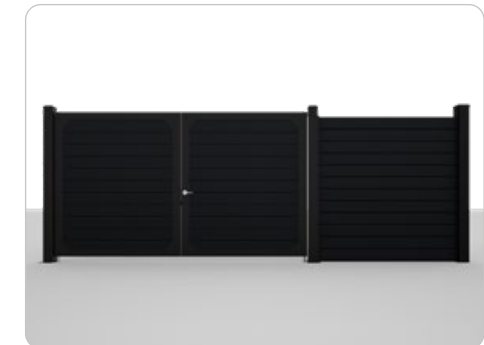

16. Installation Finished

Continue with other fence installations. Installation finished.

◆ Installing on Slope

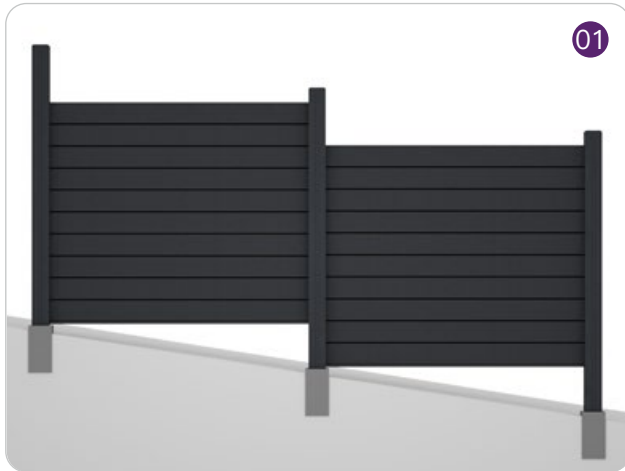

1. Step Method

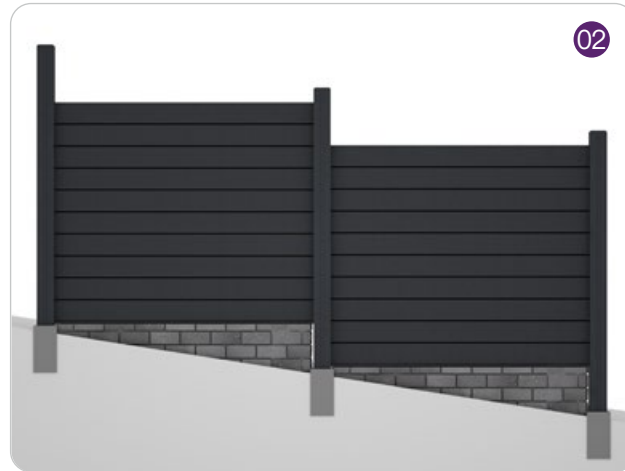

2. Filling Method

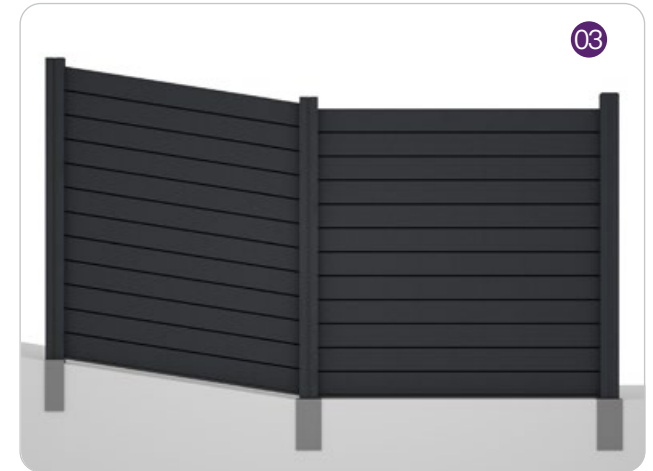

3. Following the Grade

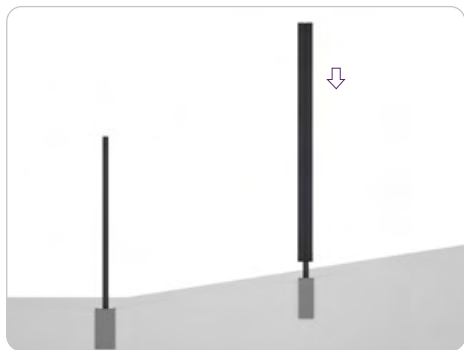

1. Set Fence Post

Dig holes more than 300 mm in depth at proper intervals and pour in concrete. Install steel bases on the concrete blocks and slide the posts over the steel bases.

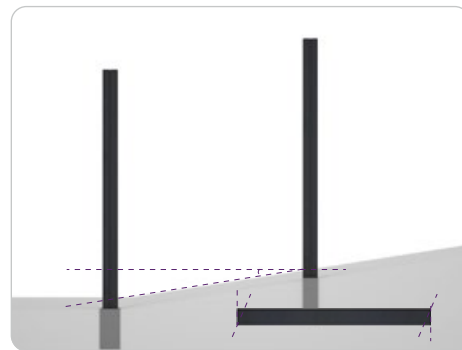

2. Trim Fencing Board

Measure the slope and trim the fencing boards accordingly to ensure a good fit.



3. Install Fencing Board

Slide in the aluminum fence base and trimmed fencing boards one by one.



4. Installation Finished

Continue the installation of the rest. Installation finished.