

Switch Product Catalog





White



Grey



Gold



Black

K2



Frame module

It can be taken apart easily to change the design rather than change the whole set



U type terminal

U type threads structure with large-diameter terminal can fasten connection

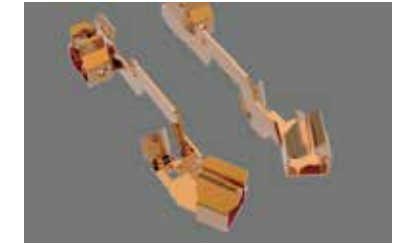

Bronze conduction

One-time finished tin-phosphor bronze metal part. Strong resilience. Resistance to wear. Lifetime 1.5 times longer than product itself



PC material

High quality imported Bayer PC
Good fineness
Uniform color
No color change for 10 years



Children safety guard

Safety guard set inside to protect children from electric shock accident



Access port

Easy to put in 3pcs of wires
Convenience for installation



Bigger panel

Size of product: 86*86mm



Power : 16AX 250V~ 1 Gang
 1 Way Switch 1 Gang 2 Way
 Switch
 : 1 Gang Multi-point Control Switch



Power : 16AX 250V~
 Gang 1 Way switch
 Gang 2 Way switch
 2 Gang Multi-point Control Switch



Power : 5~850MHz
Power : RJ11/4Wire
 Satellite TV& telephone socket



Power : RJ45 Cat6
Power : 5~850MHz
 1 way Satellite TV&
 computer socket



Power : 16AX 250V~ 3 Gang
 1 Way switch
 3 Gang 2 Way switch



Power : 16AX 250V~ 4 Gang
 1 Way switch
 4 Gang 2 Way switch



Power : RJ45 Cat6
Power : 5~850MHz
 : Television & computer socket



Power : 5~850MHz
Power : RJ11/4Wire
 Television & Telephone socket



Power : 16A 250V~
 : Door bell



Power : 16AX 250V~
K2.0MH/2 : "DON' T DISTURB" &
 "MAKE UP ROOM"
 Indicator Bell Switch



Power : 16A 250V~
 : 2 Gang US Socket



Power : 16A 250V~
 : 1 Gang US Socket



Power : 250V~
 1 Gang 20A DP Switch
 1 Gang 32A DP Switch
 1 Gang 45A DP Switch



Power : RJ45 Cat6
Power : RJ11/4Wire
K2.0DH/DN : Television & computer socket



Power : 13A 250V~
 1 gang 13A Switched socket with indicator
 1 gang 13A DP Switched
 socket with indicator



Power : 16A 250V~
 : 1 Gang 16A Switched Socket
 with Indicator



Power : 5~850MHz
 : Satellite television
 : F-type Satellite Socket
 : Secondary F-type Satellite Socket



Power : <5~850MHz
 : 1 way television socket



Power : 16A 250V~
 2 gang 2&3 Pins Universal
 switched socket with indicator



Power : 16A 250V~
 : 1 Gang Universal Switched
 Socket with Indicator



Power : RJ45 Cat6
 : 1 way computer socket



Power : RJ11/4Wire
 : 1 way telephone socket



Power : 16A 250V~ 5V 2.1A~
 : 1 Gang Switched Universal
 socket with 2 USB Port



Power : 16A 250V~
 : 1 Gang Switched Universal



Power : 16A 250V~ 1 gang
Germany socket



Power : N/A
HDMI+USB Socket
(USB for data transfer)



Power : N/A
one-piece frame assembly
(can replace by install both horizontal and vertical side)



Power : N/A
one-piece frame assembly
(can replace by install both horizontal and vertical side)



Power : N/A
VGA+F3.5 Socket



Input : 10A 220V~
Output : PD20W
1 gang usb+type c socket



Power : N/A
one-piece frame assembly
(can replace by install both horizontal and vertical side)



Power : N/A
one-piece frame assembly
(can replace by install both horizontal and vertical side)



Input : 10A 220V~
Output : PD20W
2 gang usb+type c socket



Power : 220V~ LED≤100W
Rotatable Dimmer Switch



Power : 3A
Alarm Press Button Switch



Power : 220V~ ≤300W
Fan Speed Controller Switch



Power : LED≤60W
PIR motion sensor switch



Power : LED≤60W Acoustic
light switch



Power : 30A 220V~
RF Energy Saving Card Switch
High frequency IC card Switch
Low frequency IC card Switch



Power : N/A
Front-plate



Elegant Design Excellent Quality
**Super Flat Big Key Switch
 with Multiple Socket**

Colour For Options

Four colour White , Gold , Grey ,Black for options
 BS , US , CB, BIS, IEC 60669 Standard
 High quality PC materials, flame
 resistance,high strength,not easy to fade
 Pure Cooper ,Brass ,with Iron Frame firly
 installation and with electricshock protection

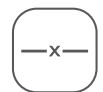

Short circuit
 protection



Overheat
 protection



Overcurrent
 protection



Overvoltage
 protection



Protection against
 electric shock



White



Grey

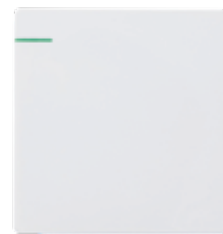

Gold



Black

K3



Frame module

It can be taken apart easily to change
 the design rather than change the
 whole set



U type terminal

U type threads structure with
 large-diameter terminal can fasten
 connection



Bronze conduction

One- time finished tin-phosphor
 bronze metal part . Strong resilience.
 Resistance to wear Lifetime 1.5 times
 longer than product itself



PC material

High quality imported Bayer PC
 Good fineness
 Uniform color
 No color change for 10 years



Children safety guard

Safety guard set inside to protect
 children from electric shock accident



Access port

Easy to put in 3pcs of wires
 Convenience for installation





Power : 16AX 250V~ 1
 Gang 1 Way Switch
 1 Gang 2 Way Switch
 : 1 Gang Multi-point Control Switch



Power : 16AX 250V~
 2 Gang 1 Way switch
 2 Gang 2 Way switch
 2 Gang Multi-point Control Switch



Power : 16A 250V~
 1 Gang Universal Switched
 Socket with Indicator



Power : 16A 250V~
 1 Gang Switched Unicersal
 socket with 2 USB Port



Power : 16AX 250V~ 3
 Gang 1 Way switch 3 Gang 2 Way
 switch



Power : 16AX 250V~ 4 Gang
 1 Way switch
 4 Gang 2 Way switch



Power : 16A 250V~
 1 Gang 16A Switched Socket
 with Indicator



Power : 16A 250V~
 2 gang 2&3 Pins Unicersal
 switched socket with indicator



Power : 16A 250V~
 : Door bell switch



Power : 16AX 250V~
 "DON' T DISTURB" & "MAKE UP
 ROOM" Indicator Bell Switch



Power : 16A 250V~
 2 & 3 Pins Universal
 Socket with Indicator
 with double USB 2.1A



Power : 16A 250V~
 1 gang Germany socket



Power : 250V~
 : 1 Gang 20A DP Switch
 : 1 Gang 45A DP Switch
 : 1 Gang 32A DP Switch



Power : 13A 250V~
 : 1 gang 13A single pole
 socket with USB+Type C



Power : 16A 250V~
 : 1 gang 13A Double 2 pins
 switched socket



Power : 220V~ ≤100W
 1 gang Fan Speed
 Controller Switch

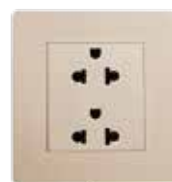

Power : 16A 250V~
 : 2 Gang US Socket

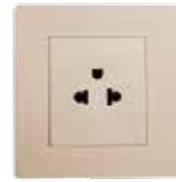

Power : 16A 250V~
 : 1 Gang US Socket

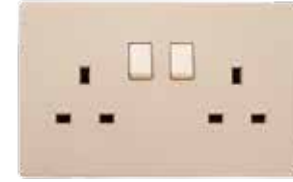

Power : 13A 250V~
 : 2 gang 13A switched socket
 : 2 gang 13A DP switched socket



Power : 13A 250V/2.1A
 : 2 gang single pole switched
 socket with USB+ Type C



Power : 13A 250V~
 : 1 gang 13A Switched
 socket with indicator
 1 gang 13A DP Switched
 socket with indicator



Power : 13A 250V~
 1 gang 13A Switched socket with indicator
 1 gang 13A DP Switched
 socket with indicator



Power : 13A 250V~
 : 2 gang 13A switched socket with indicator
 : 2 gang 13A DP switched socket with indicator

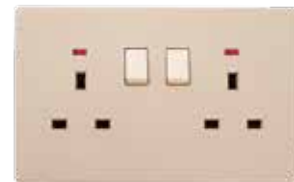

Power : 45A 250V~
 : 45a Swith with 13A socket for kitchen Unit



Power : 5~850MHZ
 : 1 way television socket
 : F-type Satellite Socket
 : Secondary F-type Satellite Socket



Power : <30V
 : 3RCA Socket



Power : 13A 250V~+5V~3A/2.1A
 : 2 gang 13A universal switched socket with indicator with 2 USB



Power : 13A 250V~
 : 2 gang 13A universal switched socket with indicator



Power : RJ11/4 Wire
K3DH : 1 way telephone socket



Power : RJ45 CAT 6
 : 1 way computer socket



Power : 5~850MHZ RJ11/4 Wire
 : Television & Telephone socket



Power : 5~850MHZ RJ45 CAT 6
 : Television & computer socket



Power : 45A 250V~
 : CABL-45A-2PW-So



Power : PD 20W
 : 1 gang 13A single pole socket with USB+Type C



Power : 5~850MHZ RJ11/4 Wire
 : Television & Telephone socket



Power : 5~850MHZ RJ45 CAT 6
 : Television & computer socket



Power : 220V~ ≤300W
 : Fan Speed Controller Switch



Power : 5W
 : Volume switch



Power : RJ11/4 Wire RJ45 CAT 6
 : Television & computer socket



Power : <1W 220V~
K3DJ : PIR motion sensor Footlight



Power : N/A
 : Alarm Press Buttom Switch



Power : 220V~ 50/60Hz
 LED<100W
 : PIR motion sensor switch



Power : N/A
 : HDMI+USB Socket



Power : N/A
 : VGA+F3.5 Socket

K3



Power : N/A
1 gang satellite TV socket



Power : LED<100W
: Rotatable LED light Dimmer Switch



Power : 220V~ 50/60Hz
Incandescent lamp≤500W
Energy saving light,
Fluorescent lamp≤200W
Acoustic light switch



Power : 16A 250V~
Energy Saving Card Switch RF
High frequency IC card Switch
Low frequency IC card Switch



Power : 1A 220V~
: "DON' T DISTURB"
Indicator Bell Switch



Power : 1A 220V~
: "DON' T DISTURB"
&"MAKE UP ROOM"
IndicatorBellSwitch



Power : 1A 220V~
DONNOT DISTURB"
& "MAKE UP ROOM"
&"WAIT AMOMENT"
Indicator Bell Switch



Power : 10A 250V~
: Ding Dong door bell



Power : N/A
: Front-plate



Power : N/A
: 146 Front-plate



Frame module

It can be taken apart easily to change the design rather than change the whole set



Bronze conduction

One- time finished tin-phosphor bronze metal part . Strong resilience. Resistance to wear Lifetime 1.5 times longer than product itself



Children safety guard

Safety guard set inside to protect children from electric shock accident



White



Grey



Gold

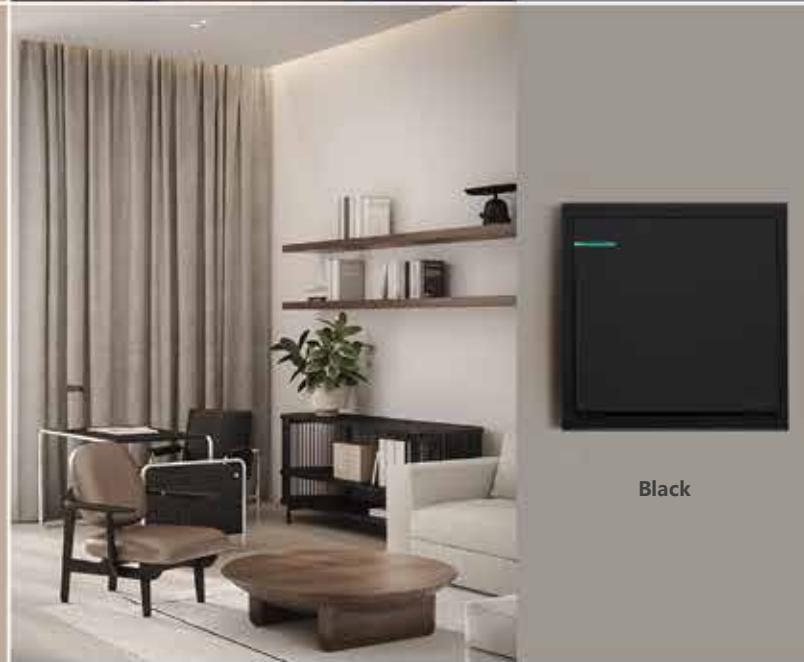

Black

K5

1. Integrated fast disassembly, Integrated Button and border, easy disassembly.
2. Size: 86*90mm
3. Sn-P bronze, Good elasticity, fatigue resistance and good electrical conductivity.
4. Silver alloy contact, Improved silver alloy contact. Excellent conductivity pure silver and the high hardness alloy. Strong arc extinguishing ability

K5



Power : 16AX 250V~ 1 Gang
1 Way Switch 1 Gang 2 Way
Switch
: Multi-point Control Switch



Power : 16AX 250V~ 2
Gang 1 Way switch
2 Gang 2 Way switch



Power : 16AX 250V~ 3
Gang 1 Way switch
3 Gang 2 Way switch



Power : 16AX 250V~ 4
Gang 1 Way switch
4 Gang 2 Way switch



Power : 16A 250V~
Door Bell



Power : 16AX 250V~
"DON' T DISTURB" & "MAKE UP
ROOM" Indicator Bell Switch



Power : 20A/45A 250V~
: 1 Gang 20A DP Switch
: 1 Gang 45A DP Switch



Power : 16A 250V~2
Gang US Socket



Power : 16AX 250V~
2x Universal Socket



Power : 16A 250V~
1 Gang 16A Switched Socket
with Indicator



Power : 13A 250V~
1 gang 13A Switched socket with indicator
1 gang 13A DP Switched
socket with indicator



Power : 16A 250V~
1 Gang Universal Switched
Socket with Indicator



Power : 16A 250V~
2 gang 2&3 Pins Unicersal
switched socket with indicator



Power : 16A 250V~
1 Gang Switched Unicersal
socket with 2 USB Port



Power : <5~850MHz
: 1 way television socket
: F-type Satellite Socket
: Secondary F-type Satellite Socket



Power : <5~850MHz
: 1 way television socket
: F-type Satellite Socket
: Secondary F-type Satellite Socket



Power : 16A 250V~
1 gang Germany socket



Power : 16A 250V~
2 & 3 Pins Universal
Socket with Indicator
with double USB 2.1A



Power : RJ45 Cat6
Power : RJ11/4Wire
Television & computer socket



Power : <30V
: 3RCA Socket



Power : 16A 250V~
1 gang 13A Double 2 pins
switched socket



Power : 220V~ ≤300W
1 gang Fan Speed
Controller Switched



Power : N/A
: VGA+F3.5 Socket



Power : N/A
HDMI+USB Socket



Power : RJ45 Cat6
1 way computer socket



Power : RJ11/4Wire
: 1 way telephone socket



Power : 220V~ ≤300W
: Fan Speed Controller Switch



Power : 220V~ ≤300W
Rotatable LED light Dimmer Switch



Power : 5~850MHz
Power : RJ11/4Wire
: Television & Telephone socket



Power : RJ45 Cat6
Power : 5~850MHz
Television & computer socket



Power : 220V~ 50/60Hz
: Incandescent lamp≤500W
Energy saving light,
Fluorescent lamp≤200W
LED≤100W
PIR motion sensor switch



Power : N/A
Footlight



Power : RJ45 Cat6
Power : 5~850MHz
Television & computer socket



Power : 5~850MHz
Power : RJ11/4Wire
elevision & Telephone socket



Power : 220V~ 50/60Hz
: Incandescent lamp≤500W
Energy saving light,
Fluorescent lamp≤200W
LED≤100W
Acoustic light switch



Power : 3A 250V~
Alarm Press Button Switch

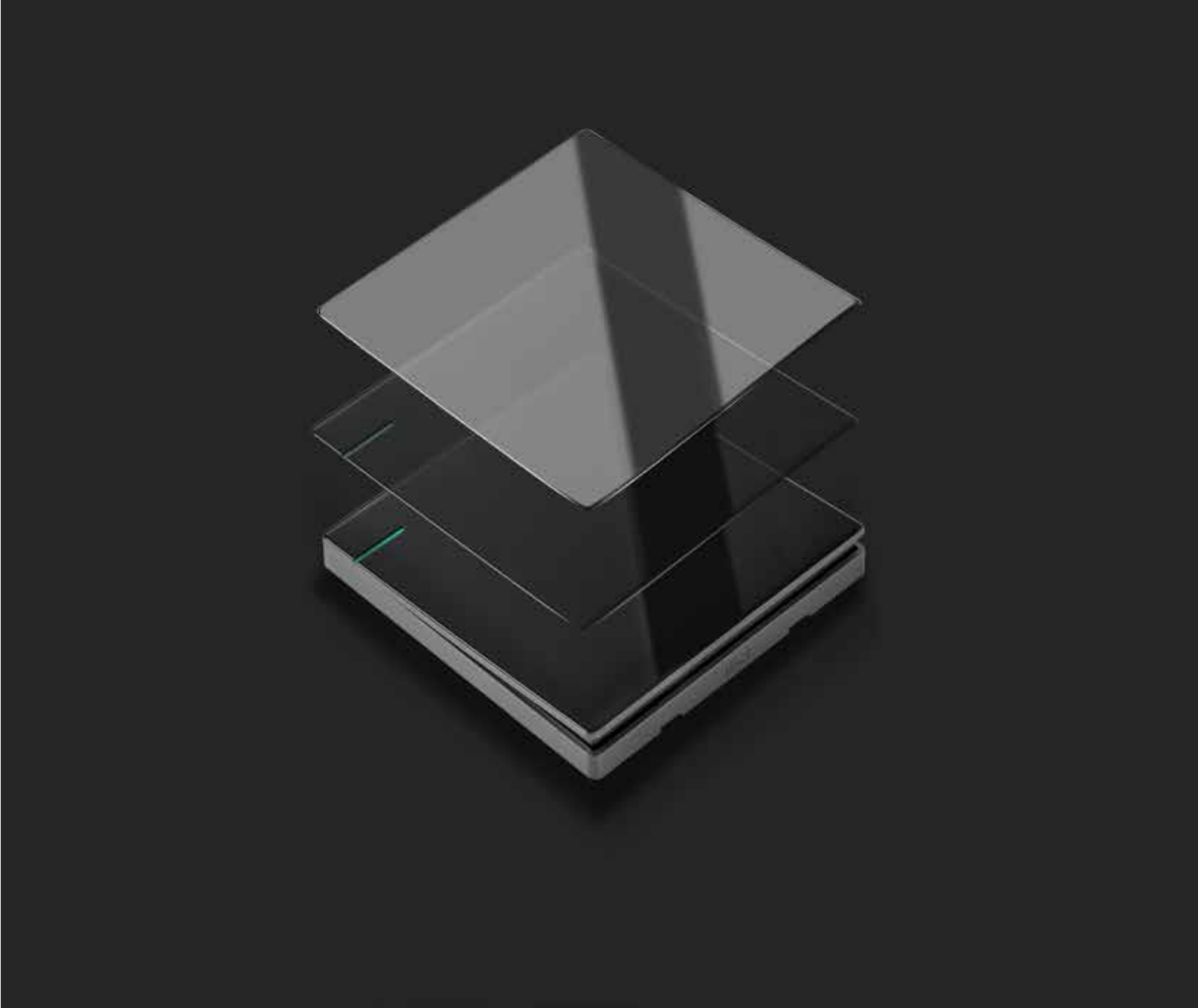

K8



Crystal clear,
smooth and delicate;



High hardness tempered
glass,not afraid of rubbing,
lasting clean



2.5D arc design with smooth
edges and corners;



PA
66

PA66 material
Adopted DuPont PA66 to protective door and the pin tumbler

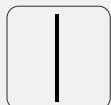

Single line structure
Two or three, four gang switches use single-line structure, easy and fast installation



Bigger panel
Size of product: 86*90mm



Stainless panel 304



K8

Stainless steel series

K8



Power : 16AX 250V~
1 gang one way switch
1 Gang 2 Way Switch
: Multi-point Control Switch



Power : 16AX 250V~
2 Gang 1 Way switch
2 Gang 2 Way switch
2 Gang Multi-point Control Switch



Power : 16AX 250V~ K3
Gang 1 Way switch
3 Gang 2 Way switch



Power : 16AX 250V~
4 Gang 1 Way switch
4 Gang 2 Way switch



Power : 16AX 250V~
: Door bell



Power : 16AX 250V~
"DON' T DISTURB" & "MAKE UP ROOM" Indicator Bell Switch



Power : 250V~
: 1 Gang 20A DP Switch
: 1 Gang 45A DP Switch
: 1 Gang 32A DP Switch



Power : 16A 250V~
1 gang Germany socket



Power : 16A 250V~
: 2 Gang US Socket



Power : 16A 250V~
: 1 Gang US Socket



Power : 13A 250V~
: 1 gang 13A Switched socket
1 gang 13A DP Switched socket



Power : 13A 250V~
1 gang 13A Switched socket with indicator
1 gang 13A DP Switched socket with indicator



Power : 16A 250V~
1 Gang Universal Switched Socket with Indicator



Power : 16A 250V~
1 Gang 16A Switched Socket with Indicator



Power : 13A 250V~/2.1A
: 2 gang single pole switched socket with USB+ Type C



Power : 45A 250V~
: 45a Swith with 13A socket for kitchen Unit



Power : 16A 250V~
2 Gang 2 & 3 Pins Universal Switched Socket with Indicator



Power : 16A 250V~/2.1A 5V
1 Gang Switched Universal Socket with 2 USB Port



Power : 13A 250V~/+5V-2.1A
: 2 gang 13A universal switched socket with indicator with 2 USB



Power : 13A 250V~
: 2 gang 13A universal switched socket with indicator



Power : 16A 250V~
2 & 3 Pins Universal Socket with Indicator with double USB 2.1A



Power : 13A 250V~
1 gang 13A single pole socket with USB+Type C



Power : 45A 250V~
: 45A cable outlet



Power : PD20W
1 gang 13A single pole socket with USB+Type C



Power : 16A 250V~
1 gang 13A Double 2 pins switched socket



Power : 220V~ ≤200W
1 gang Fan Speed Controller Switch



Power : 220V~ ≤300W
: Fan Speed Controller Switch



Power : 5W
: Volume switch



Power : 13A 250V~
: 2 gang 13A switched socket
: 2 gang 13A DP switched socket



Power : 13A 250V~
: 2 gang 13A switched socket with indicator
: 2 gang 13A DP switched socket with indicator



Power : 3A 250W
Alarm Press Buttom Switch



Power : LED ≤100W
PIR motion sensor switch



Power : 5~850MHZ
 : 1 way television socket
 : F-type Satellite Socket
 : Secondary F-type Satellite Socket



Power : <30V
 : 3RCA Socket



Power : N/A
 : satellite TV socket



Power : 220V~ ≤300W
 : Rotatable Dimmer Switch



Power : RJ11/4 Wire
 : 1 way telephone socket



Power : RJ45 CAT 6
 : 1 way computer socket



Power : 220V~ 50/60Hz
 Incandescent lamp≤500W
 Energy saving light,
 Fluorescent lamp≤200W
 Acoustic light switch



Power : 16A 250V~
 : Energy Saving Card Switch
 High frequency IC card Switch
 Low frequency IC card Switch



Power : 5~850MHZ RJ11/4 Wire
 : Television & Telephone socket



Power : 5~850MHZ RJ45 CAT 6
 : Television & computer socket



Power : N/A
 : Front-plate



Power : 16AX 250V~
 : Ding Dong door bell



Power : 5~850MHZ RJ11/4 Wire
 : Television & Telephone socket



Power : 5~850MHZ RJ45 CAT 6
 : Television & computer socket



Power : RJ11/4 Wire RJ45 CAT 6
 : Television & computer socket



Power : <1W 220V~
 : PIR motion sensor Footlight



Power : N/A
 : HDMI+USB Socket



Power : N/A
 : VGA+F3.5 Socket



V6

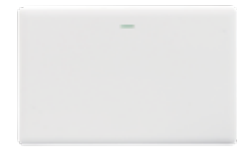

Power : 10AX 250V~
1 gang 1 way switch with indicator
1 gang 2 way switch with indicator



Power : 10AX 250V~
2 gang 1 way switch with indicator
2 gang 2 way switch with indicator



Power : 10AX 250V~
3 gang 2 way switch with indicator

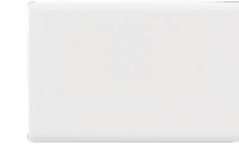

Power : N/A
Front-plate

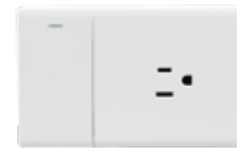

Power : 16A 250V~
1 gang 1 way with US
socket with indicator
1 gang 2 way with US
socket with indicator

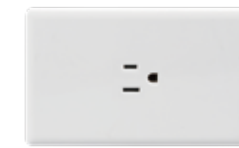

Power : 16A 250V~ 1
gang US socket



Power : 10AX 250V~
2 gang US socket with switch



Power : 16A 250V~ 2
gang US socket



Power : 16A 250V~
2 gang US socket with two USB

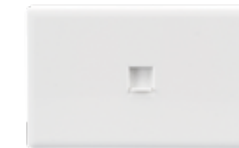

Power : RJ11/4Wire
Telephone socket



Power : RJ45 5e
V6DN : Computer socket

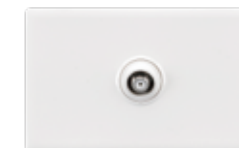

Power : 50~850MHz
Television socket



Power : 220V~200W
Fan Speed Controller Switch



Power : 220V~200W
Rotatable Dimmer Switch



Power : 5-850MHz JJ45 5e
Gang 2 Pin Socket



Black



Gold

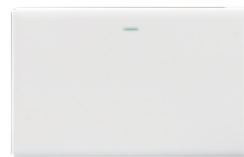

White



Grey

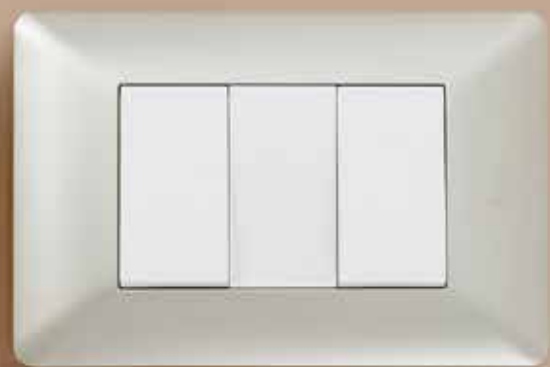

V8

1. Fireproof PC Panel, High strength, high and low temperature resistance. Not easy to fade, easy to clean, eco-friendly.
2. Free combination, Various module for choice, flexible installation.
3. Copper lock safety door, Child-proof safety door design.
4. Install screw, Form a complete set of built-in install screw, convenient installation and service content.
5. High-quality Copper, No riveting, one-piece molding, silver alloy contact, sensitive reaction, excellent electrical conductivity.

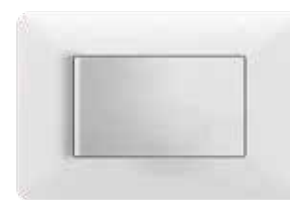

White



Almond

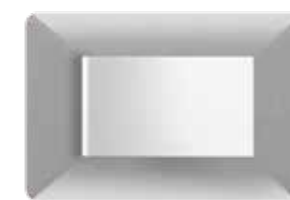

Grey



Gold



Power : 16AX 250V~
1 Gang 1 way switch
1 Gang 2 Way Switch



Power : 16AX 250V~
1 Gang Double Pole Switch



Power : 16A 250V~
Universal Socket



Power : 16A 250V~
2 Gang 2+3 pin
universal Socket

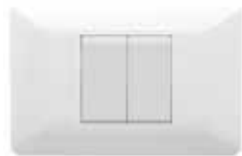

Power : 16AX 250V~
2 Gang 1 way switch
2 Gang 2 Way Switch

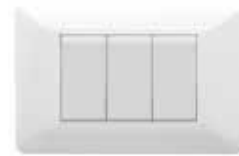

Power : 16AX 250V~
3 Gang 1 way switch
3 Gang 2 Way Switch
4 Gang 2 Way Switch



Power : 16A 250V~
1 Gang German Socket



Power : 16A 250V~
US Socket with Switch



Power : 16AX 250V~
Door Bell switch



Power : 20A 250V~
1 Gang 20A DP Switch
with Indicator



Power : 50~850MHz
1 Way Television



Power : RJ45 Cat6
Power : RJ11/4Wire
Telephone & computer Socket



Power : 16A 250V~
1 Gang 2 Pin&
Universal Socket



Power : 16A 250V~
2 Gang Italy socket



Power : RJ11/4Wire
1 Way Telephone Socket



Power : RJ45 Cat6
1 Way Computer Socket



Power : 16A 250V~
Gang 2 Pin Socket



Power : 16A 250V~
Twin 2 Pin Socket



Power : RJ45 Cat6
Power : 5~850MHz
Television & Computer Socket



Power : 5~850MHz
Power : RJ11/4Wire
Television & Telephone Socket



Power : 16A 250V~
1 Gang US Socket



Power : 16A 250V~
2 Gang US socket



Power : 300W 220V~
Fan Speed Controller Switch



Power : 300W 220V~
Dimmer Switch

V8



Power : 2.1A 5V~
Double USB Charger Socket



Input : 10A 220V~
Output : one gang USB+Type C Socket



Power : 16A 250V~
2 Gang US socket



Power : N/A
Front-plate



Power : 16A 250V /USB+C10A 220V
Output : one gang US socket with USB+Type C



Power : 16A 250V
1 Gang US socket with Switch

V8 SIZE

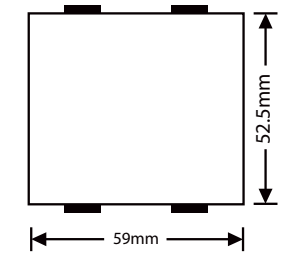
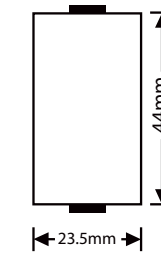
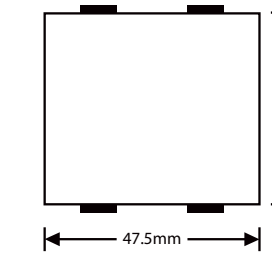
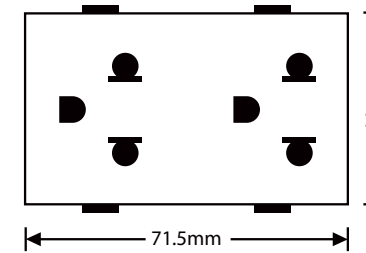
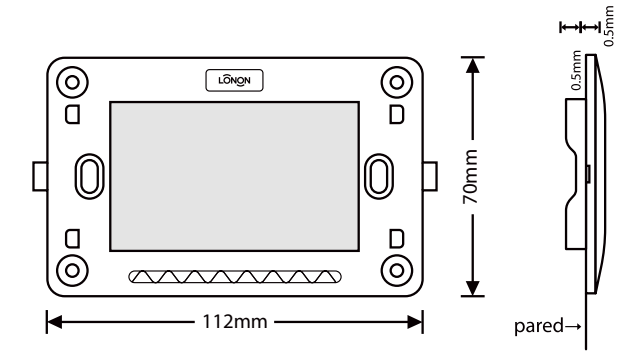
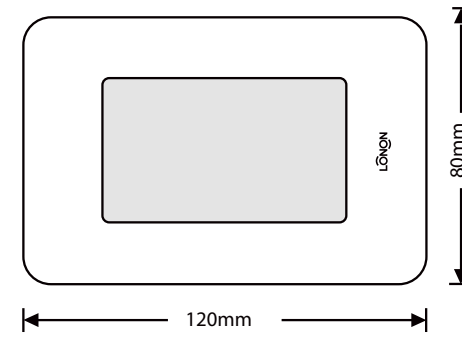

V8 SPARE PARTS

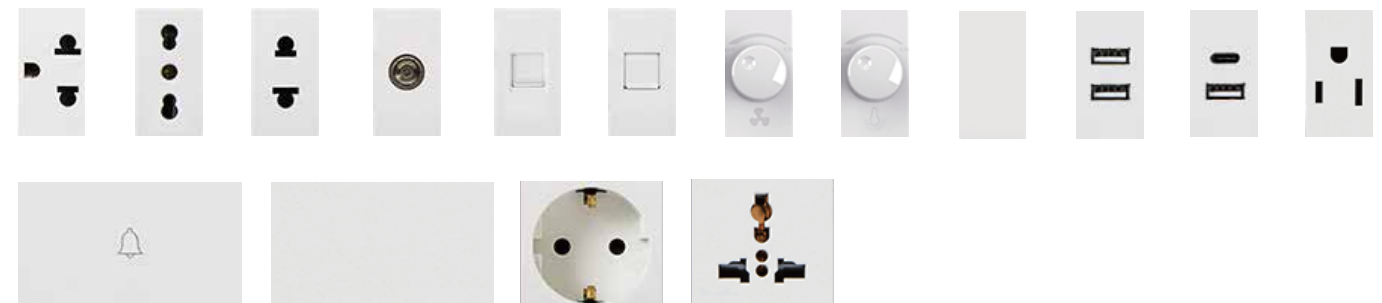



V9

Series Features

1. Standard 118 Type, 118*80mm.
2. Fireproof PC Panel, High strength, high and low temperature resistance. Not easy to fade, easy to clean, eco-friendly.
3. Free combination, Various module for choice, flexible installation.
4. Copper lock safety door, Child-proof safety door design.
5. Good Structure, Sturdy steel frame structure, Copper cast structure
6. Install screw, Containing install screw, convenient installation and service content.
7. High-quality Copper, No riveting, one-piece molding, silver alloy contact sensitive reaction excellent electrical conductivity



Stainless



Glass



White



Flat pane/glass/stainless



Iron frame strong support



Children protection



Pc material



Copper lock safety door



High-quality copper



Power : 10AX 250V~ 1
Gang 1 Way Switch
1 Gang 2 Way Switch



Power : 10AX 250V~
1 Gang double pole switch



Power : RJ11/4Wire
1 Way Telephone Socket



Power : RJ45 Cat6
1 Way Computer Socket



Power : 10AX 250V~
2 Gang 1 Way Switch
2 Gang 2 Way Switch



Power : 10AX 250V~
3 Gang 1 Way Switch
3 Gang 2 Way Switch



Power : RJ45 Cat6
Power : RJ11/4Wire
Telephone & Computer Socket



Power : 5~850MHz
Power : RJ11/4Wire
Television & Telephone Socket



Power : 10A 250V~
Door Bell Switch



Power : 16A 250V~
1 Gang 2 Pin Socket



Power : RJ45 Cat6
Power : 5~850MHz
Television & Computer Socket



Power : 50~850MHz
1 Way Television Socket



Power : 16A 250V~
Twin 2 Pin Socket



Power : 16A 250V~
1 Gang US Socket



Power : N/A
Fan Speed Control Switch



Power : N/A
Dimmer Switch

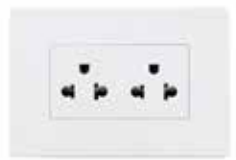

Power : 16A 250V~ V
2 Gang US Socket



Power : 16A 250V~
Universal Socket



Power : 2.1A 5V
USB Charger Socket



Power : N/A
Front-plate



Power : 16A 250V~
1 Gang 2 Pin &
Universal Socket



Power : 16A 250V~
1 Gang 1 Way Switch
& US Socket



Power : 16A 250V
1 gang Universal socket
with 2gang USB socket



Power : 16A 250V
1 Gang US socket
with 2gang USB



B9

Glass series of B8

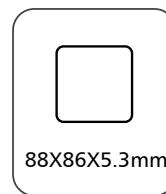
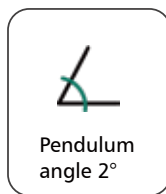



B8



Frame module
It can be taken apart easily to change the design rather than change the whole set



U type terminal
U type threads structure with large-diameter terminal can fasten connection



Bronze conduction
One-time finished tin-phosphor bronze metal part. Strong resilience. Resistance to wear. Lifetime 1.5 times longer than product itself



PC material
High quality imported Bayer PC
Good fineness
Uniform color
No color change for 10 years



Children safety guard
Safety guard set inside to protect children from electric shock accident



Access port
Easy to put in 3pcs of wires
Convenience for installation

B8



White



Grey



Gold



Black





Power : 16AX 250V~
 1 gang 1 way switch
 1 gang 2 way switch
 1 gang Multi-point Control Switch



Power : 16AX 250V~
 2 gang 1 way switch
 2 gang 2 way switch
 2 gang Multi-point Control Switch



Power : N/A
 HDMI Socket



Power : PD 65W
 2 gang USB & Type C
 socket PD 65W



Power : 16AX 250V~ 3
 gang 1 way switch
 3 gang 2 way switch



Power : 16AX 250V~
 4 gang 1 way switch 4 gang 2
 way switch



Power : 220V~ 5W
 Volume Controller



Power : 220V~ LED ≤100W
 : Dimmer Switch
 (LED load/Silicon controlled)



Power : 16A 250V~
 : Door bell



Power : 250V~
 1 Gang 32A DP Switch
 1 Gang 45A DP Switch



Power : 220V~ 250W
 Rotatable Fan Dimmer Switch



Power : LED ≤50W
 Acoustic light switch (two lines)



Power : 13A 250V~
 1 gang 13A DP Switched socket



Power : 13A 250V~ / USB PD18W
 1 gang 13A single pole
 socket with USB+Type C
 fast charger



Power : 5~850MHz
 45° Satellite TV Socket



Power : LED ≤60W
 PIR motion sensor switch



Power : 45A 250V~
 45A Swith with 13A socket for kitchen Unit



Power : 16A 250V~
 2 gang 13A DP switched socket



Power : 16A 250V~ / USB PD18W
 : 2 gang 13A single pole socket with
 USB+Type C ' fast' charger



Power : 16A 250V~ 5V 2.1A~
 1 Gang Switched Unicersal
 socket with 2 USB Port



Power : 5~850MHz
 Power : RJ11/4Wire
 : Television & Telephone socket



Power : RJ45 Cat6
 Power : 5~850MHz
 Television & computer socket



Power : RJ45 Cat6
 : 1 way computer socket



Power : RJ11/4Wire
 : 1 way telephone socket



Power : RJ11/4Wire RJ45 Cat6
 :



Power : RJ11/4Wire
 : 2 way telephone socket



Power : RJ45 Cat6
 : 2 way computer socket



Power : N/A
 : Front-plate



IP20 WAHTERPROOF COVER - 86 size



IP55 WAHTERPROOF COVER - 86 size



IP20 WAHTERPROOF COVER - 146 size



IP20 WAHTERPROOF COVER - 118 size



JUNCTION BOX - 146 size



JUNCTION BOX - 86 size



IP66 COVER BOX-146/276 size



IP66 COVER BOX-86 size



Installation accessory frame

(can replace by install both horizontal and vertical side)



FLOOR SOCKET POP UP

-  Conexión conveniente
-  Sistema Impermeable
-  Protección infantil
-  sistema de amortiguación



Brass FLOOR SOCKET



Power : 13A 250V~
British 13A 3 Pin Floor Socket-Brass



Power : 13A 250V~
3 Pin Universal Floor Socket-Brass



Power : 16A 250V~
Germany Socket-Brass French Floor Socket-Brass



Power : 16A 250V~
1 Gang US Floor Socket-Brass



Power : 16A 250V~
2 Gang US Floor Socket-Brass



Power : RJ45 Cat6
1 Gang Computer Socket-Brass



Power : 16A 250V~
1 Gang USB Floor Socket-Brass



Power : 16A 250V~
2 Pin Floor Socket-Brass



Power : 16A 250V~
2 Pin & 3 Pin Universal Floor Socket-Brass



Power : 15A 250V~
15A 3 Round Socket-Brass

STAINLESS STEEL FLOOR SOCKET



Power : 16A 250V~
2 Gang US Floor
Socket-Stainless Steel



Power : 13A 250V~
3 Pin Universal Floor
Socket-Stainless Steel



Power : 15A 250V~
15A 3 Round
Socket-Stainless Steel



Power : 16A 250V~
1 Gang US Floor
Socket-Stainless Steel



Power : 16A 250V~
1 Gang USB Floor
Socket-Stainless Steel



Power : 16A 250V~
2 Pin & 3 Pin Universal
Floor Socket-Stainless Steel



Power : 13A 250V~
British 13A 3 Pin Floor
Socket-Stainless Steel



Power : 16A 250V~
Germany Socket-Stainless Steel
French Floor
Socket-Stainless Steel



Power : 16A 250V~
2 Pin Floor
Socket-Stainless Steel



Power : RJ45 Cat6
1 Gang Computer
Socket-Stainless Steel

FLOOR SOCKET SIZE

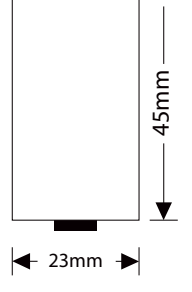
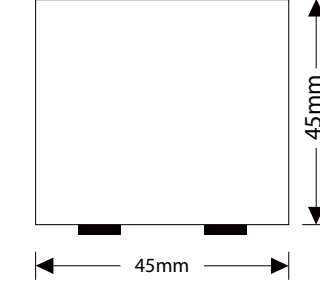
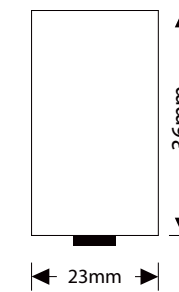
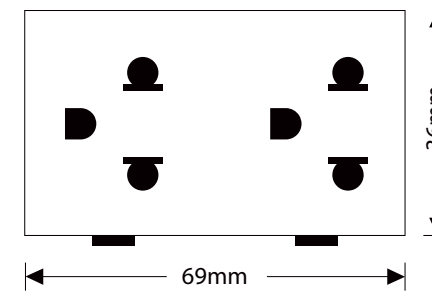
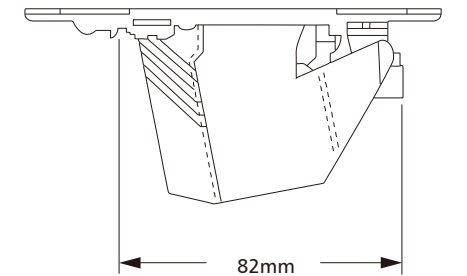
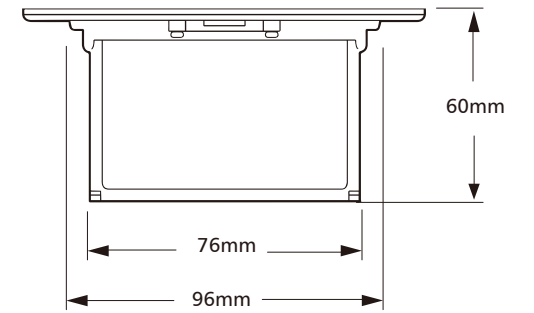
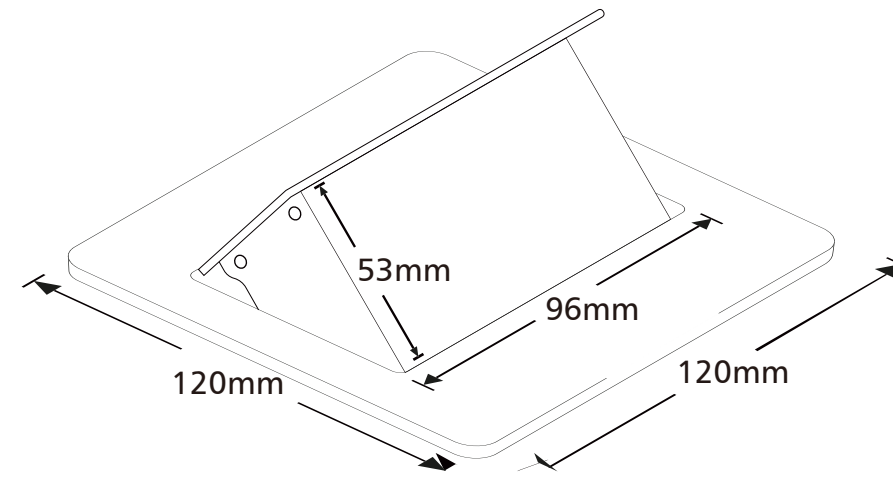

FLOOR SOCKET SPARE PARTS

