

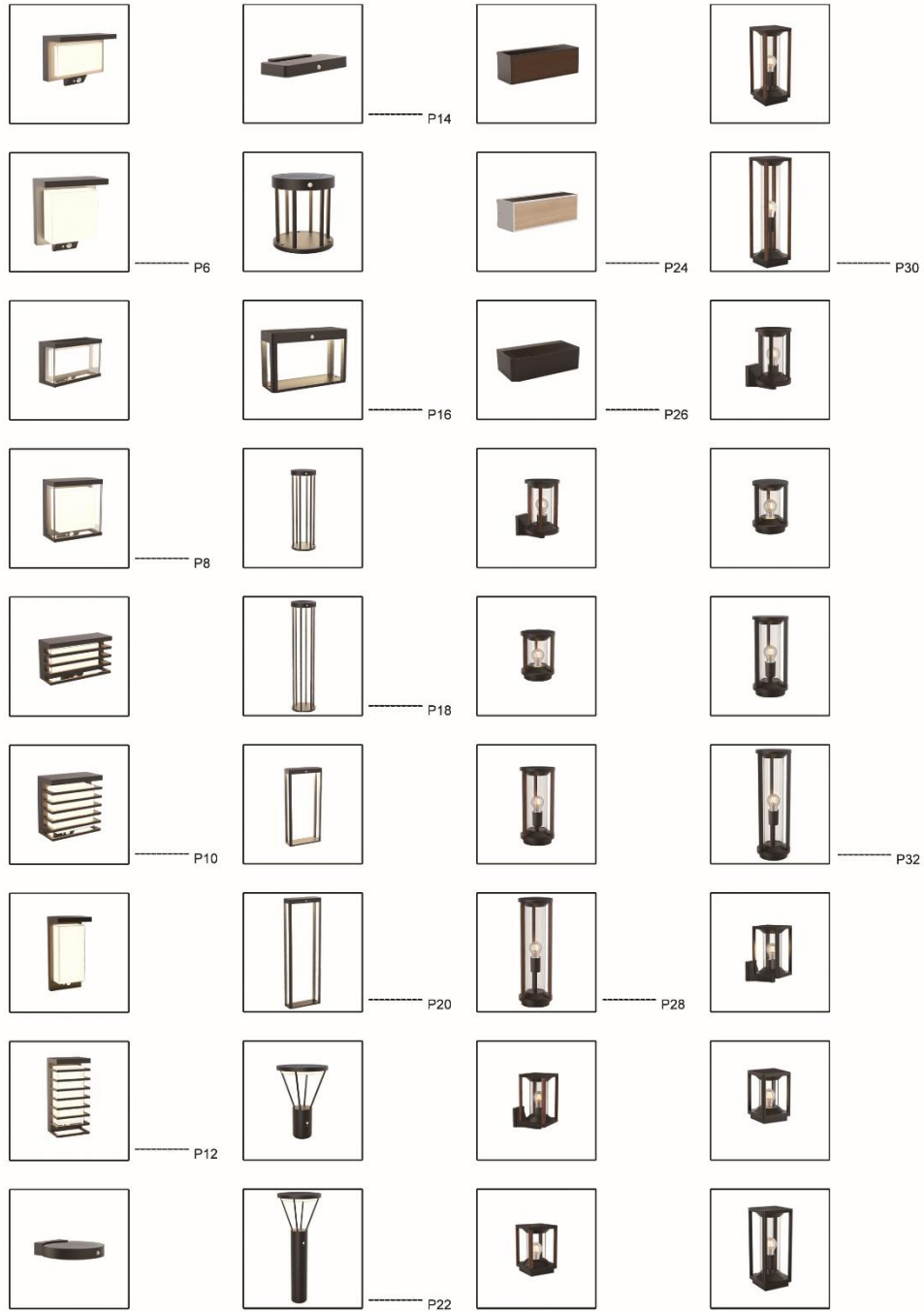

Solar Lights Catalog

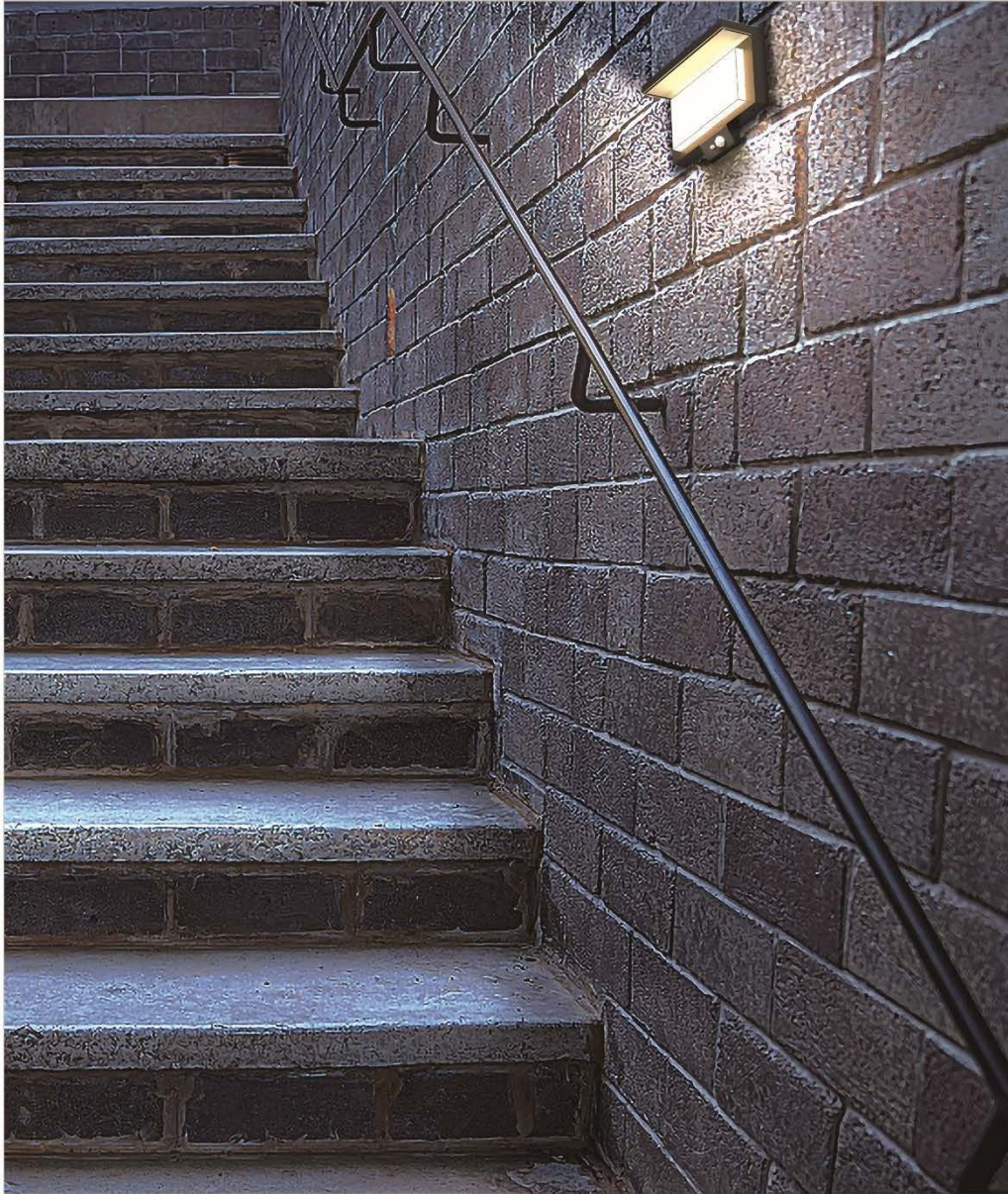





Solar Panel: 1.5W

Battery: 1 x Li-ion battery
2200mAh

Voltage: 3.7V

Material: Diecasting aluminum
+ Frost PC

Body Color: Dark Grey/Silver/White
/Rust/Black/Anthracite

Technical data

LED DIMMER

2W 2700k6500k

130 lm(3000k)

Beam Angle: 79.2°

CRI≥82

IP65



GPS-01



GPS-02

Discharge Time

Mode 1: Max. 400 (sensing times)

Mode 2: >14H

Mode 3: Max. 500 (sensing times)

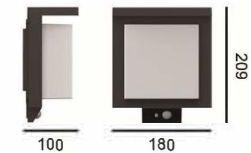
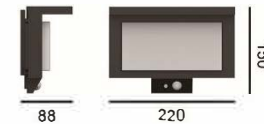



Solar Panel: 1.5W
 Battery: 1 x Li-ion battery
 2200mAh
 Voltage: 3.7V

Material: Die-casting aluminum
 + Frost PC + Clear glass
 Body Color: Dark Grey/Silver/White
 /Rust/Black/Anthracite

Technical data

LED DIMMER
 2W 2700k-6500k
 85 lm(3000k)
 Beam Angle: 75.6°
 CRI≥82
 IP65



GPS-03



GPS-04

Discharge Time

Mode 1: Max. 400 (sensing times)
 Mode 2: >14H
 Mode 3: Max. 500 (sensing times)

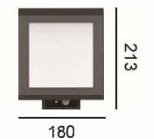



Solar Panel: 1.5W
 Battery: 1 x Li-ion battery
 2200mAh
 Voltage: 3.7V

Material: Die-casting aluminum
 + Frost PC
 Body Color: Dark Grey/Silver/White
 /Rust/Black/Anthracite

Technical data

LED DIMMER
 2W 2700k-6500k
 75 lm(3000k)
 Beam Angle: 76.7*
 CRI≥82
 IP65

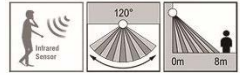

GPS-05



GPS-06

Discharge Time

Mode 1: Max. 400 (sensing times)
 Mode 2: >14H
 Mode 3: Max. 500 (sensing times)

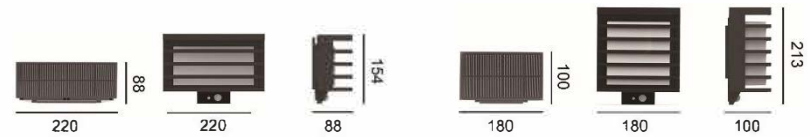



Solar energy lamp



Solar Panel: 1W
 Battery: 1 x Li-ion battery
 2200mAh
 Voltage: 3.7V

Material: Die-casting aluminum
 + Frost PC
 Body Color: Dark Grey/Silver/White
 /Rust/Black/Anthracite



GPS-07

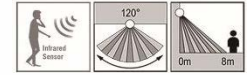

GPS-08

Technical data

LED DIMMER
 1W 2700k-6500k
 100 lm(3000k)
 Beam Angle: 87.3°
 CRI≥82
 IP65

Discharge Time

Mode 1: Max. 400 (sensing times)
 Mode 2: >14H
 Mode 3: Max. 500 (sensing times)

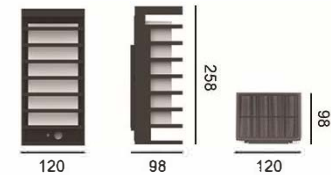
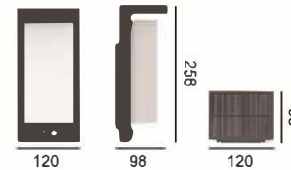

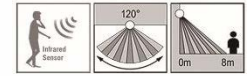
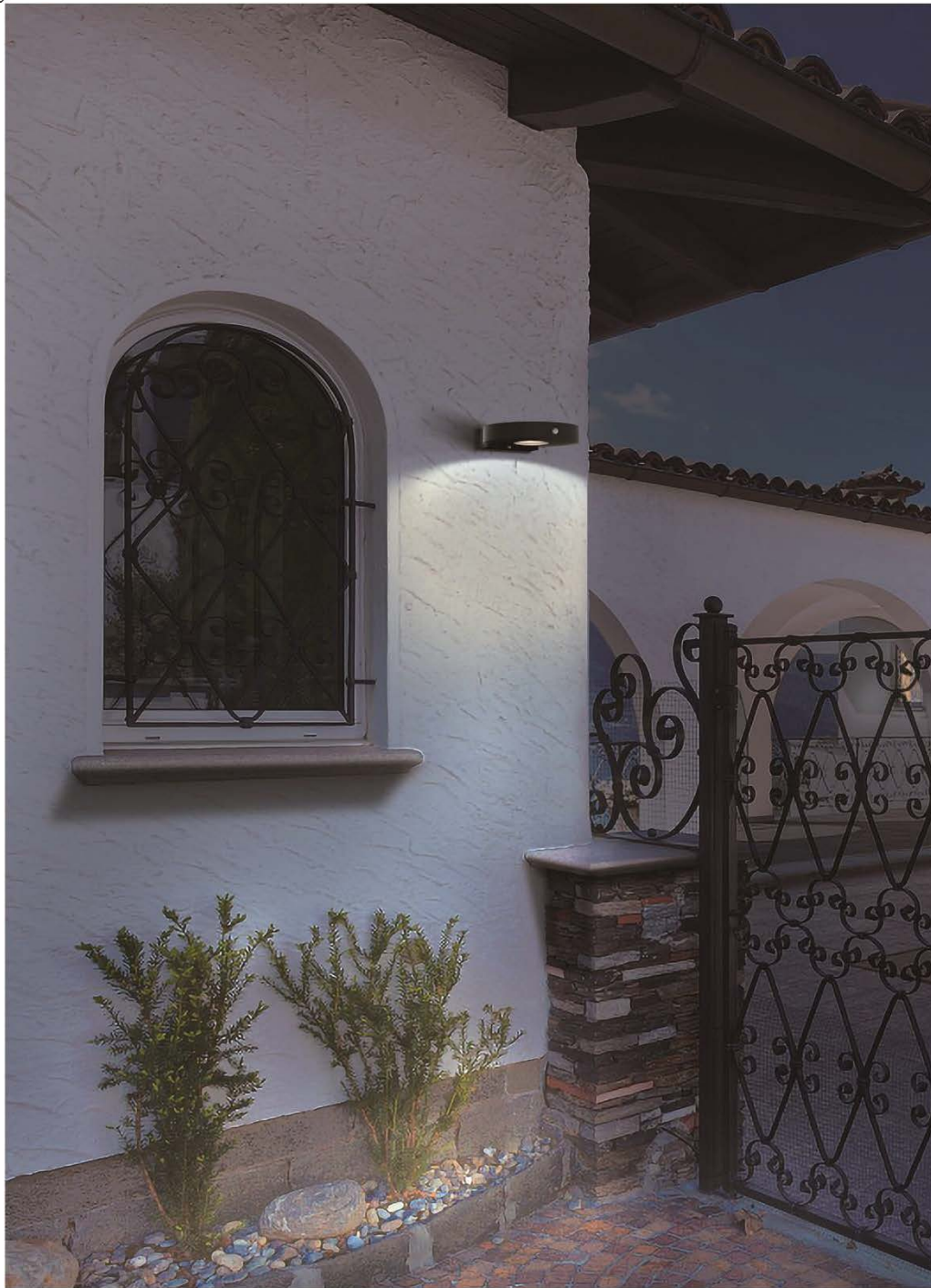

Solar Panel: 2W
 Battery: 1 x Li-ion battery
 2200mAh
 Voltage: 3.7V

Material: Die-casting aluminum
 + Clear glass
 Body Color: Dark Grey/Silver/White
 /Rust/Black/Anthracite



GPS-09



GPS-10

Technical data

LED DIMMER
 2W 2700k-6500k
 161 lm(3000k)
 Beam Angle: 82.8°
 CRI≥82
 IP65

Discharge Time

Mode 1: Max. 400 (sensing times)
 Mode 2: >14H
 Mode 3: Max. 500 (sensing times)

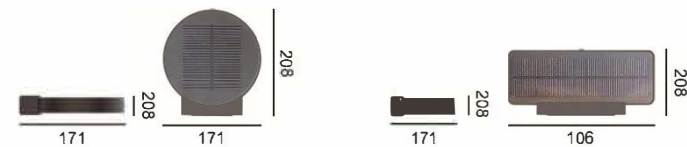



Solar Panel: 2W
 Battery: 1 x Li-ion battery
 2200mAh
 Voltage: 3.7V

Material: Die-casting aluminum
 + Clear glass

Body Color: Dark Grey/Silver/White
 /Rust/Black/Anthracite



GPS-11



GPS-12

Technical data

LED DIMMER
 2W 2700k-6500k
 156 lm(3000k)
 Beam Angle: 162.6°
 CRI≥82
 IP65

Discharge Time

Mode 1: Max. 400 (sensing times)
 Mode 2: >14H
 Mode 3: Max. 500 (sensing times)

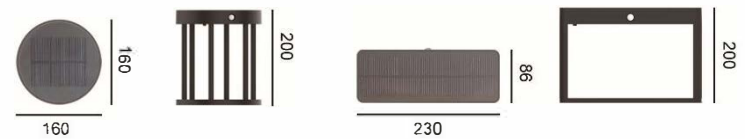



Solar Panel: 2W
 Battery: 1 x Li-ion battery
 2200mAh
 Voltage: 3.7V

Material: Die-casting aluminum
 + Clear glass

Body Color: Dark Grey/Silver/White
 /Rust/Black/Anthracite



Technical data

LED DIMMER
 2W 2700k-6500k
 152 lm(3000k)
 Beam Angle: 168.3°
 CRI≥82
 IP65 Ⓢ V Ⓢ CE

Discharge Time

Mode 1: Max. 400 (sensing times)
 Mode 2: >14H
 Mode 3: Max. 500 (sensing times)

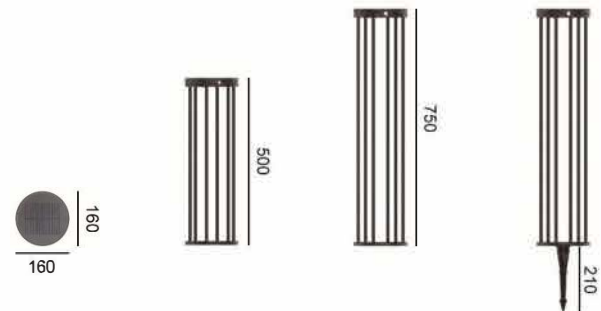



Solar energy lamp



Solar Panel: 1.5W
 Battery: 1 x Li-ion battery
 2200mAh
 Voltage: 3.7V

Material: Die-casting aluminum
 + Clear glass
 Body Color: Dark Grey/Silver/White
 /Rust/Black/Anthracite



GPS-15

GPS-16

Technical data

LED DIMMER
 2W 2700k-6500k
 151 lm(3000k)
 Beam Angle: 164-8°
 CRI≥82
 IP65

Discharge Time

Mode 1: Max. 400 (sensing times)
 Mode 2: >14H
 Mode 3: Max. 500 (sensing times)

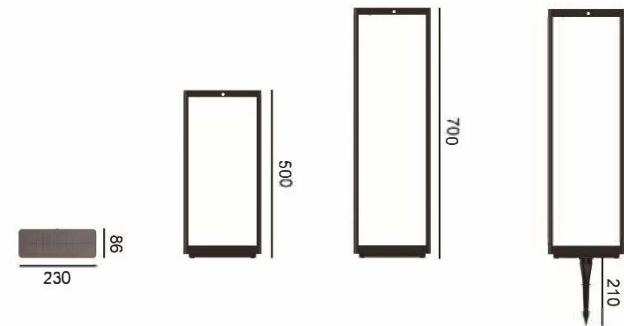



Solar energy lamp



Solar Panel: 8 W
 Battery: 2 x Li-ion battery
 2200mAh
 Voltage: 3.7V

Material: Die-casting aluminum
 + Frost PC
 Body Color: Dark Grey/Silver/White
 /Rust/Black/Anthracite



GPS-17

GPS-18

Technical data

LED DIMMER
 5W 2700k-6500k
 285 lm(3000k)
 Beam Angle: 173.2°
 CRI≥82
 IP65@VCE

Discharge Time

Mode 1: Max. 400 (sensing times)
 Mode 2: >12H
 Mode 3: Max. 500 (sensing times)

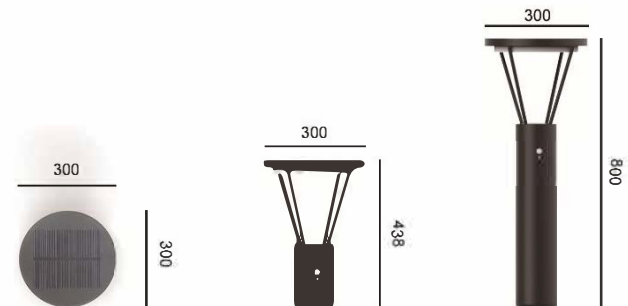



Solar Panel: 1.5W
 Battery: 1 x Li-ion battery
 2200mAh
 Voltage: 3.7V

Material: Die-casting aluminum
 + Clear Glass
 Body Color: Dark Grey/Silver/White
 /Rust/Black/Anthracite



Technical data

LED DIMMER
 1.5W 2700k-6500k
 121 lm(3000k)
 Beam Angle: 88.1°
 CRI≥82
 IP65

GPS-19

Discharge Time > 14

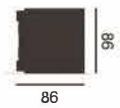



Solar Panel: 1.5W
 Battery: 1 x Li-ion battery
 2200mAh
 Voltage: 3.7V

Material: Die-casting aluminum
 + Clear Glass

Body Color: Dark Grey/Silver/White
 /Rust/Black/Anthracite



GPS-20

Technical data

LED DIMMER
 1.5W 2700k-6500k
 165 lm(3000k)
 Beam Angle: 84.6°
 CRI≥82
 IP65

Discharge Time > 14





Solar Panel: 1.5W
 Battery: 1 x Li-ion battery
 2200mAh
 Voltage: 3.7V

Material: Die-casting aluminum
 + Clear PC
 Body Color: Dark Grey/Silver/White
 /Rust/Black/Anthracite
 E27 · 3V · Max 4W



GPS-21



GPS-22



GPS-23



GPS-24

E27LED    IP65 Discharge Time > 12H

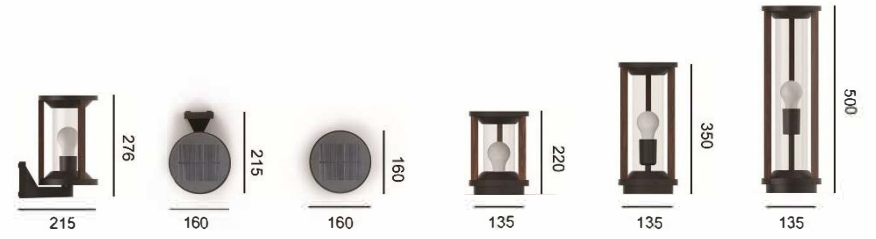



Solar energy lamp



Solar Panel: 1.5W
 Battery: 1 x Li-ion battery
 2200mAh
 Voltage: 3.7V

Material: Die-casting aluminum
 + Clear PC
 Body Color: Dark Grey/Silver/White
 /Rust/Black/Anthracite
 E27 · 3V · Max 4W



GPS-25



GPS-26



GPS-27



GPS-28

E27LED   

IP65

Discharge Time > 14H

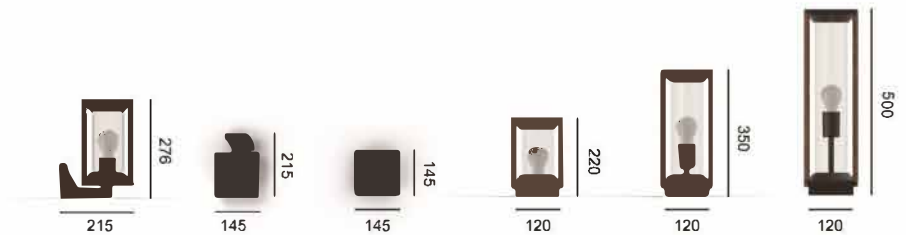





Solar energy lamp



Solar Panel: 1.5W
 Battery: 1 x Li-ion battery
 2200mAh
 Voltage: 3.7V

Material: Die-casting aluminum
 + Clear PC
 Body Color: Dark Grey/Silver/White
 /Rust/Black/Anthracite
  E27 · 3V · Max 4W



GPS-29



GPS-30



GPS-31



GPS-32

E27LED   

IP65

Discharge Time > 12H

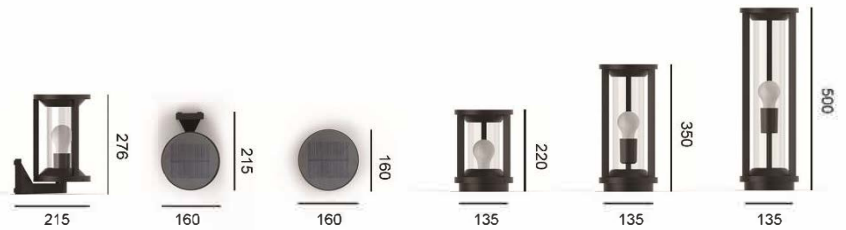



Solar energy lamp



Solar Panel: 2W
 Battery: 1 x Li-ion battery
 2200mAh
 Voltage: 3.7V



GPS-33

Material: Die-casting aluminum
 + Clear PC
 Body Color: Dark Grey/Silver/White
 /Rust/Black/Anthracite
 E27 · 3V · Max 4W



GPS-34



GPS-35



GPS-36

E27LED



IP65

Discharge Time > 12H



276

215

145

145



220

120



350

120



500

120



Solar energy lamp



Solar Panel: 1.5W
 Battery: 1 x Li-ion battery
 2200mAh
 Voltage: 3.7V

Material: Die-casting aluminum
 + Frost PC
 Body Color: Dark Grey/Silver/White
 /Rust/Black/Anthracite



GPS-37



GPS-38

Technical data

LED DIMMER
 2W 2700k-6500k
 96 lm(3000k)
 Beam Angle: 90.2°
 CRI≥82
 IP65

Discharge Time

Mode 1: Max. 400 (sensing times)
 Mode 2: >14H
 Mode 3: Max. 500 (sensing times)

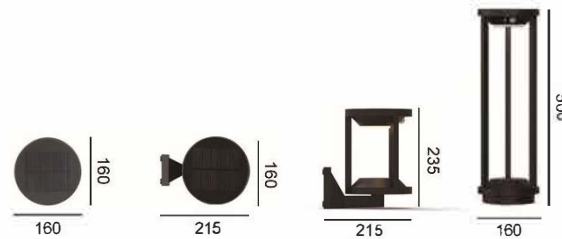



Solar Panel: 1.5W
 Battery: 1 x Li-ion battery
 2200mAh
 Voltage: 3.7V

Material: Die-casting aluminum
 + Frost PC
 Body Color: Dark Grey/Silver/White
 /Rust/Black/Anthracite



GPS-39

Technical data

LED DIMMER
 2W 2700k-6500k
 115 lm(3000k)
 Beam Angle: 83.1°
 CRI≥82
 IP65

Discharge Time

Mode 1: Max. 400 (sensing times)
 Mode 2: >14H
 Mode 3: Max. 500 (sensing times)

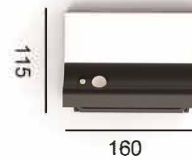

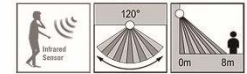

Solar Panel: 1.5W
 Battery: 1 x Li-ion battery
 2200mAh
 Voltage: 3.7V

Material: Die-casting aluminum
 + Clear glass
 Body Color: Dark Grey/Silver/White
 /Rust/Black/Anthracite



GPS-40

Technical data

LED DIMMER
 2W 2700k-6500k
 219lm(3000k)
 Beam Angle: 100°
 CRI≥82
 IP65

Discharge Time

Mode 1: Max. 400 (sensing times)
 Mode 2: >14H
 Mode 3: Max. 500 (sensing times)

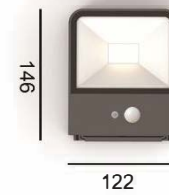



Solar Panel: 1.5W
 Battery: 1 x Li-ion battery
 2200mAh
 Voltage: 3.7V

Material: Die-casting aluminum
 + Frost PC
 Body Color: Dark Grey/Silver/White
 /Rust/Black/Anthracite



GPS-41

Technical data

LED DIMMER
 2W 2700k-6500k
 104 lm(3000k)
 Beam Angle: 66.8°
 CRI≥82
 IP65

Discharge Time

Mode 1: Max. 400 (sensing times)
 Mode 2: >14H
 Mode 3: Max. 500 (sensing times)

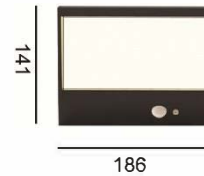



Solar energy lamp



Solar Panel: 1.5W
 Battery: 1 x Li-ion battery
 2200mAh
 Voltage: 3.7V

Material: Die-casting aluminum
 + Frost PC
 Body Color: Dark Grey/Silver/White
 /Rust/Black/Anthracite



GPS-42



GPS-43

Technical data

LED DIMMER
 2W 2700k-6500k
 130 lm(3000k)
 Beam Angle: 143.5°
 CRI>82
 IP65

Discharge Time

Mode 1: Max. 400 (sensing times)
 Mode 2: >14H
 Mode 3: Max. 500 (sensing times)

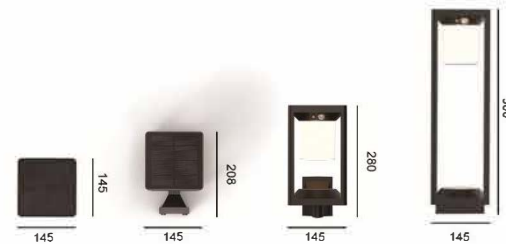

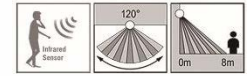

Solar Panel: 1.5W
 Battery: 1 x Li-ion battery
 2200mAh
 Voltage: 3.7V

Material: Die-casting aluminum
 + Frost PC
 Body Color: Dark Grey/Silver/White
 /Rust/Black/Anthracite



GPS-44

Technical data

LED DIMMER
 2W 2700k-6500k
 90 lm(3000k)
 Beam Angle: 120°
 CRI≥82
 IP65

Discharge Time

Mode 1: Max. 400 (sensing times)
 Mode 2: >14H
 Mode 3: Max. 500 (sensing times)





Solar Panel: 1.5W
 Battery: 1 x Li-Ion battery
 2200mAh
 Voltage: 3.7V

Material: Die-casting aluminum
 + Frost PC
 Body Color: Dark Grey/Silver/White
 /Rust/Black/Anthracite



GPS-45



GPS-46

Technical data

LED DIMMER
 2W 2700k-6500k
 92 lm(3000k)
 Beam Angle: 120.1°
 CRI≥82
 IP65

Discharge Time

Mode 1: Max. 400 (sensing times)
 Mode 2: >14H
 Mode 3: Max. 500 (sensing times)





Solar Panel: 1W
 Battery: 1 x Li-ion battery
 2200mAh
 Voltage: 3.7V

Material: Diecasting aluminum
 + Clear glass + Frost PC
 Body Color: Dark Grey/Silver/White
 /Rust/Black/Anthracite



GPS-47

Technical data

LED DIMMER
 1W 2700k-6500k
 73 lm(3000k)
 Beam Angle: 77.7°
 CRI≥82
 IP65@VCE

Discharge Time

Mode 1: Max. 400 (sensing times)
 Mode 2: >14H
 Mode 3: Max. 500 (sensing times)





Solar Panel: 0.5W
 Battery: 1 x Li-ion battery
 2200mAh
 Voltage: 3.7V

Material: Die-casting aluminum
 + Clear glass
 Body Color: Dark Grey/Silver/White
 /Rust/Black/Anthracite



GPS-48

Technical data

LED DIMMER
 1W 2700k-6500k
 63 lm(3000k)
 Beam Angle: 84°
 CRI≥82
 IP65

Discharge Time

Mode 1: Max. 400 (sensing times)
 Mode 2: >14H
 Mode 3: Max. 500 (sensing times)

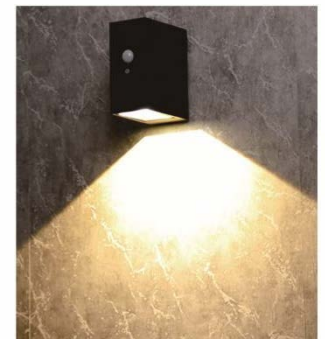
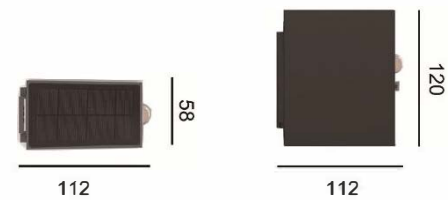



Solar Panel: 0.7W
 Battery: 1 x Li-ion battery
 2200mAh
 Voltage: 3.7V

Material: Die-casting aluminum
 + Clear glass

Body Color: Dark Grey/Silver/White
 /Rust/Black/Anthracite

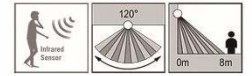

GPS-49

Technical data

LED DIMMER
 1W 2700k-6500k
 39 lm(3000k)
 Beam Angle: 58.6°
 CRI≥82
 IP65

Discharge Time

Mode 1: Max. 400 (sensing times)
 Mode 2: >14H
 Mode 3: Max. 500 (sensing times)

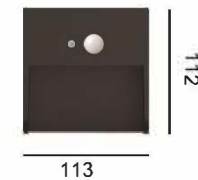
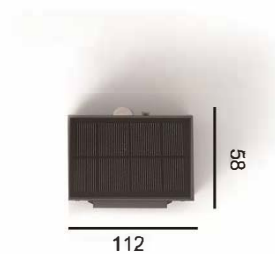

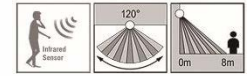

Solar Panel: 0.6W
 Battery: 2 x Li-ion battery
 2200mAh
 Voltage: 3.7V

Material: Die-casting aluminum
 + Clear glass
 Body Color: Dark Grey/Silver/White
 /Rust/Black/Anthracite



GPS-50

Technical data

LED DIMMER
 1W 2700k-6500k
 45 lm(3000k)
 Beam Angle: 276.6°
 CRI≥82
 IP65

Discharge Time

Mode 1: Max. 400 (sensing times)
 Mode 2: >14H
 Mode 3: Max. 500 (sensing times)

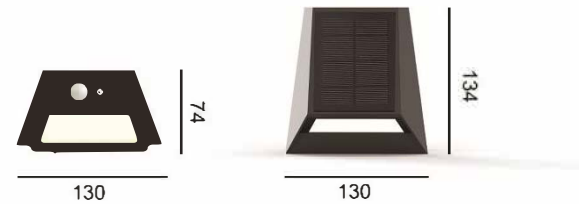



Solar energy lamp



Solar Panel: 1 W
 Battery: 1 x Li-ion battery
 2200mAh
 Voltage: 3.7V

Material: Die-casting aluminum
 + Clear PC + Frost PC
 Body Color: Dark Grey/Silver/White
 /Rust/Black/Anthracite



GPS-51



GPS-52

Technical data

LED DIMMER
 2W 2700k-6500k
 240 lm(3000k)
 Beam Angle: 123.5°
 CRI≥82
 IP65

Discharge Time

Mode 1: Max. 400 (sensing times)
 Mode 2: >14H
 Mode 3: Max. 500 (sensing times)

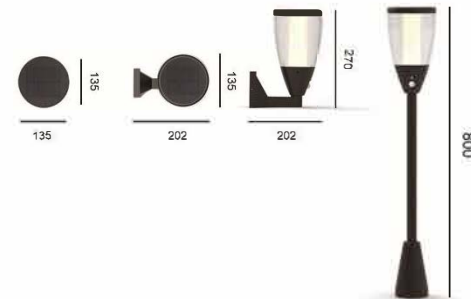



Solar Panel: 1.5W
 Battery: 1 x Li-ion battery
 2200mAh
 Voltage: 3.7V

Material: Die-casting aluminum
 + Clear glass
 Body Color: Dark Grey/Silver/White
 /Rust/Black/Anthracite



GPS-53

Technical data

LED DIMMER
 2W 2700k-6500k
 95 lm(3000k)
 Beam Angle: 80°
 CRI≥82
 IP65

Discharge Time

Mode 1: Max. 400 (sensing times)
 Mode 2: >14H
 Mode 3: Max. 500 (sensing times)

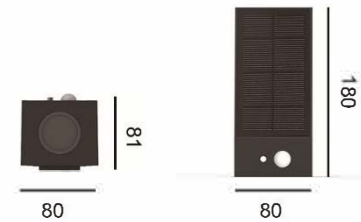

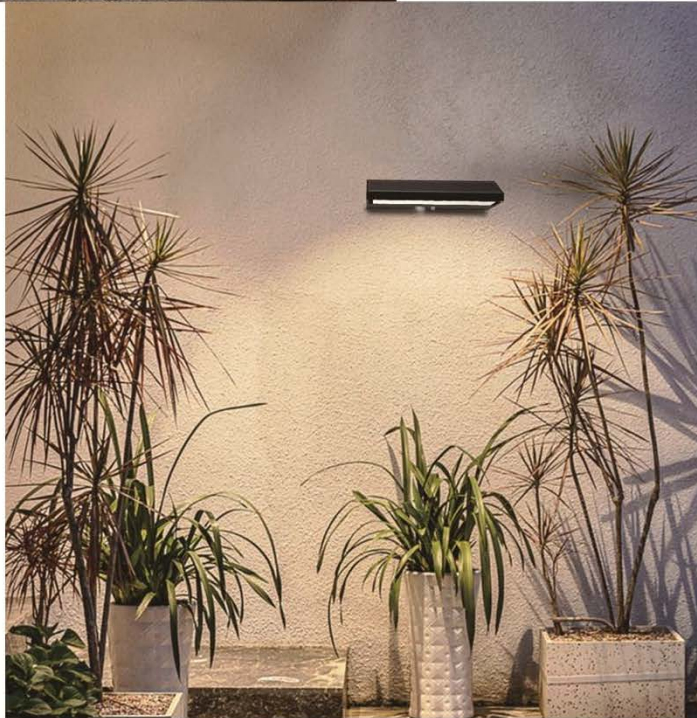

Solar energy lamp



Solar Panel: 2W
 Battery: 1 x Li-ion battery
 2200mAh
 Voltage: 3.7V

Material: Die-casting aluminum
 + Clear glass
 Body Color: Dark Grey/Silver/White
 /Rust/Black/Anthracite



GPS-54

Technical data

LED DIMMER
 2W 2700k-6500k
 198 lm(3000k)
 Beam Angle: 99.8°
 CRI≥82
 IP65

Discharge Time

Mode 1: Max. 400 (sensing times)
 Mode 2: >14H
 Mode 3: Max. 500 (sensing times)

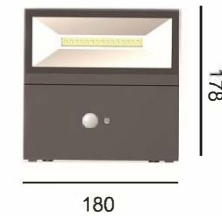
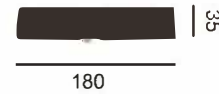



Solar Panel: 0.55 W
 Battery: 1 x Li-ion battery
 2200mAh
 Voltage: 3.7V

Material: Diecasting aluminum
 + Clear PC + Frost PC
 Body Color: Dark Grey/Silver/White
 /Rust/Black/Anthracite

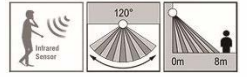

GPS-55



GPS-56

Technical data

LED DIMMER
 1W 2700k-6500k
 92 lm(3000k)
 Beam Angle: 86°
 CRI≥82
 IP65

Discharge Time

Mode 1: Max. 400 (sensing times)
 Mode 2: >14H
 Mode 3: Max. 500 (sensing times)





Solar Panel: 1W
 Battery: 1 x Li-ion battery
 2200mAh
 Voltage: 3.7V

Material: Die-casting aluminum
 + Clear PC + Frost PC
 Body Color: Dark Grey/Silver/White
 /Rust/Black/Anthracite



GPS-57



GPS-58

Technical data

LED DIMMER
 1.5W 2700k-6500k
 103 lm(3000k)
 Beam Angle: 101.3°
 CRI≥82
 IP65

Discharge Time>14H

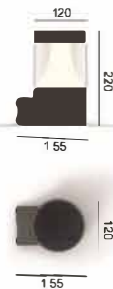



Solar energy lamp



Solar Panel: 1 W
 Battery: 1 x Li-ion battery
 2200mAh
 Voltage: 3.7V

Material: Diecasting aluminum
 + Clear PC + Frost PC
 Body Color: Dark Grey/Silver/White
 /Rust/Black/Anthracite



GPS-59



GPS-60

Technical data

LED DIMMER
 1.5W 2700k6500k
 528 lm(3000k)
 Beam Angle: 136.1°
 CRI≥82
 IP65

Discharge Time > 14H

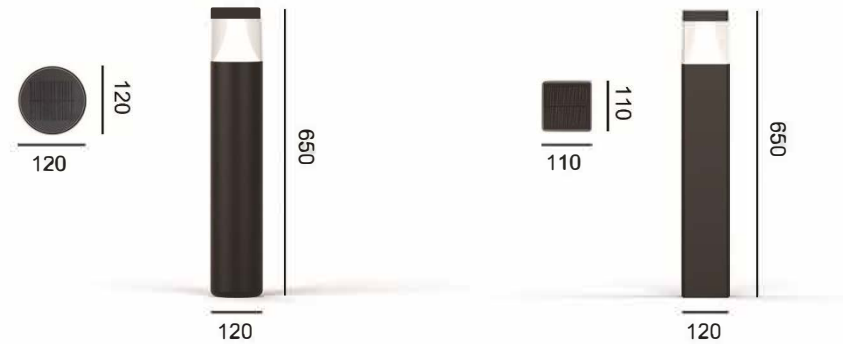



Solar energy lamp



Solar Panel: 1.5 W
 Battery: 1 x Li-ion battery
 2200mAh
 Voltage: 3.7V

 Material: Die-casting aluminum
 + Clear PC + Frost PC
 Body Color: Dark Grey/Silver/White
 /Rust/Black/Anthracite



GPS-61



GPS-62

Technical data

LED DIMMER
 2W 2700k-6500k
 245 lm(3000k)
 Beam Angle: 123.5°
 CRI≥82
 IP65 Ⓢ Ⓥ Ⓢ Ⓒ Ⓢ Ⓒ

Discharge Time > 14H

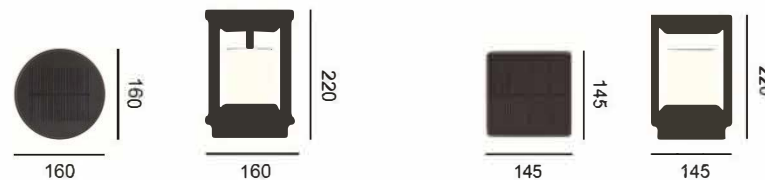



Solar energy lamp



Solar Panel: 1.5 W
 Battery: 1 x Li-ion battery
 2200mAh
 Voltage: 3.7V

Material: Die-casting aluminum
 + Frost PC
 Body Color: Dark Grey/Silver/White
 /Rust/Black/Anthracite

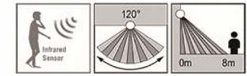

GPS-63

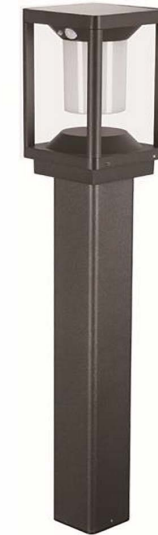

GPS-64

Technical data

LED DIMMER
 2W 2700k-6500k
 137 lm(3000k)
 Beam Angle: 90.1°
 CRI≥82
 IP65

Discharge Time

Mode 1: 400 times sense
 Mode 2: >14H
 Mode 3: 500 time sense

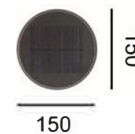

150



750

150



146

146



750

146



Solar Panel: 1.5 W / 2.5W
 Battery: 1 x Li-ion battery
 2200mAh
 Voltage: 3.7V

Material: Die-casting aluminum
 + Frost PC
 Body Color: Dark Grey/Silver/White
 /Rust/Black/Anthracite



GPS-65



GPS-66

Technical data

LED DIMMER
 1.5W 2700k-6500k
 245 lm(3000k)
 Beam Angle: 123.5°
 CRI≥82
 IP65 Ⓢ V CE

Discharge Time > 14H

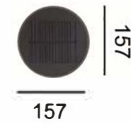

157



750

157

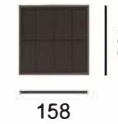

158



750

158

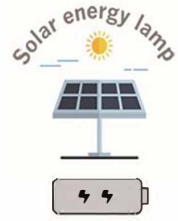

Solar Panel: 2W
 Battery: 2 x Li-ion battery
 2200mAh
 Voltage: 3.7V

Material: Die-casting aluminum
 + Clear glass
 Body Color: Dark Grey/Silver/White
 /Rust/Black/Anthracite



GPS-67



GPS-68

Technical data

LED DIMMER
 2W 2700k-6500k
 181 lm(3000k)
 Beam Angle: 74.2
 CRI>82
 IP65

Discharge Time

Mode 1: Max. 400 (sensing times)
 Mode 2: >14H
 Mode 3: Max. 500 (sensing times)

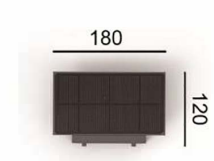
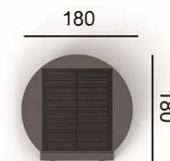
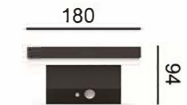
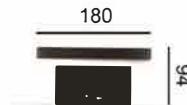

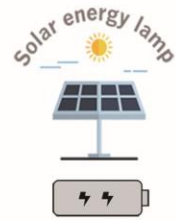

- Solar Panel: 2 W
- Battery: 1 x Li-ion battery
2200mAh
- Voltage: 3.7V

- Material: Die-casting aluminum
+ Frost PC
- Body Color: Dark Grey/Silver/White
/Rust/Black/Anthracite



GPS-69



GPS-70

Technical data

- LED DIMMER
- 1.5W 2700k-6500k
- 151 lm(3000k)
- Beam Angle: 70.7°
- CRI≥82
- IP65

Discharge Time > 14H

